



MATERIAL:	ACERO INOXIDABLE AISI 316 - A4
TERMINACIÓN:	PULIDO BRILLANTE
DIMENSIONES en PULGADAS:	NORMA ANSI B18.2.2
DIMENSIONES en MÉTRICAS:	NORMA DIN 934
<b>DESCUENTOS:</b>	<b>BASE DE INOXIDABLE</b>

## PRECIOS DE TUERCA HEXAGONAL EN PULGADA

Codigo: 150	CANTIDAD POR CAJA	ROSCA UNC-WITH	ALTURA	LLAVE	PRECIO (U\$S/1000)
000	5.000	1/8- 40	2,25	1/4	
001	4.000	5/32- 32	3,00	5/16	342,07
002	3.000	3/16- 24	3,30	3/8	290,13
003	1.500	1/4- 20	5,50	7/16	346,44
004	600	5/16- 18	6,70	1/2	417,20
005	500	3/8- 16	8,30	9/16	616,41
006	350	7/16- 14	9,30	11/16	1.480,13
007	200	1/2- 13	11,00	3/4	1.480,13
008	200	1/2- 12 w	11,00	3/4	1.480,13
009	150	9/16- 12	12,00	7/8	3.196,43
010	100	5/8- 11	14,00	15/16	2.892,59
011	90	3/4- 10	16,30	1 1/8	5.444,15
012	60	7/8- 9	19,00	1 1/4	12.256,46
013	30	1"- 8	22,00	1 1/2	18.616,20
014	24	1 1/8- 7	24,00	1 5/8	34.350,22
015	18	1 1/4- 7	27,00	1 7/8	42.937,78
017	9	1 1/2- 6	32,00	2 1/4	67.488,03

## PRECIOS DE TUERCA HEXAGONAL MÉTRICAS

Codigo: 152	CANTIDAD POR CAJA	ROSCA MA	ALTURA	LLAVE	PRECIO (U\$S/1000)
000	10.000	M3- 0,50	2,40	5,50	475,32
001	5.000	M4- 0,70	3,20	7,00	423,34
002	4.000	M5- 0,80	4,00	8,00	378,92
003	2.000	M6- 1,00	5,00	10,00	482,50
004	750	M8- 1,25	6,50	13,00	764,20
005	400	M10- 1,50	8,00	17,00	1.139,37
006	200	M12- 1,75	10,00	19,00	2.264,70
007	150	M14- 2,00	11,00	22,00	3.808,12
008	100	M16- 2,00	13,00	24,00	4.543,86
009	90	M18- 2,50	15,00	27,00	9.237,24
010	90	M20- 2,50	16,00	30,00	10.397,68
011	60	M22- 2,50	17,00	32,00	11.763,30
012	40	M24- 3,00	18,50	36,00	11.774,00
015	20	M30- 3,50	24,00	46,00	25.656,00



<b>MATERIAL:</b>	<b>ACERO INOXIDABLE AISI 316 - A4</b>
<b>TERMINACIÓN:</b>	<b>PULIDO BRILLANTE</b>
<b>DIMENSIONES en PULGADAS:</b>	<b>NORMA ANSI B18.2.2</b>
<b>DESCUENTOS:</b>	<b>BASE DE INOXIDABLE</b>

## PRECIOS DE TUERCA HEXAGONAL PESADA

<b>Codigo:</b> 153	<b>CANTIDAD POR CAJA</b>	<b>ROSCA UNC-WITH</b>	<b>ALTURA</b>	<b>LLAVE</b>	<b>PRECIO (U\$S/1000)</b>
004	500	5/16- 18	7,54	9/16	662,56
005	500	3/8- 16	9,12	11/16	1.213,56
006	350	7/16- 14	10,71	3/4	1.766,73
007	200	1/2- 13	12,30	7/8	2.665,10
008	200	1/2- 12 w	12,30	7/8	2.665,10
010	100	5/8- 11	15,47	1 1/16	6.405,34
011	90	3/4- 10	18,65	1 1/4	8.028,99
012	60	7/8- 9	21,82	1 7/16	12.781,50
013	30	1"- 8	25,00	1 5/8	20.449,80
014	14	1 1/8- 8	28,20	1 13/16	25.240,00
015	12	1 1/4- 8	31,00	2"	34.361,60
016	9	1 3/8- 8	34,90	2 5/32	51.945,20
017	7	1 1/2- 8	37,30	2 3/8	57.924,80
018	1	1 5/8- 8 x	41.1	2 9/16	9.694,24 *
019	1	1 3/4- 8 x	44.2	2 11/16	12.415,36 *
020	1	1 7/8- 8 x	47.7	2 7/8	16.603,12 *
021	1	2"- 8 x	50.5	3 1/8	19.286,16 *

LOS PRECIOS NO INCLUYEN IVA

\* LOS PRECIOS SON POR 100 UNIDADES

Actualización 19/8/2024

MOLINA ARROTEA 1150 LOMAS DE ZAMORA (1832) BS. AS.

TEL: (+54 11) 4243 5823 / 4392 4278 / 4292 0965

E-MAIL : VENTAS@TUBULON.COM.AR

WEB: WWW.TUBULON.COM.AR



<b>MATERIAL:</b>	<b>ACERO INOXIDABLE AISI 316 - A4</b>
<b>TERMINACIÓN:</b>	<b>PULIDO BRILLANTE</b>
<b>DIMENSIONES en PULGADAS:</b>	<b>NORMA SAE J483A</b>
<b>DIMENSIONES en MÉTRICAS:</b>	<b>NORMA DIN 1587</b>
<b>DESCUENTOS:</b>	<b>BASE DE INOXIDABLE</b>

## PRECIOS DE TUERCA CIEGAS EN PULGADAS

<b>Codigo</b> <b>154</b>	<b>CANTIDAD</b> <b>POR CAJA</b>	<b>ROSCA</b> <b>UNC-WITH</b>	<b>ALTURA</b>	<b>LLAVE</b>	<b>PRECIO</b> <b>(U\$S/1000)</b>
<b>002</b>	<b>1.500</b>	<b>3/16- 24</b>	<b>9,50</b>	<b>3/8</b>	<b>1.292,58</b>
<b>003</b>	<b>1.000</b>	<b>1/4- 20</b>	<b>10,50</b>	<b>7/16</b>	<b>1.431,38</b>
<b>004</b>	<b>600</b>	<b>5/16- 18</b>	<b>12,00</b>	<b>1/2</b>	<b>2.161,81</b>
<b>005</b>	<b>400</b>	<b>3/8- 16</b>	<b>14,00</b>	<b>9/16</b>	<b>2.944,40</b>

LOS PRECIOS NO INCLUYEN IVA

## PRECIOS DE TUERCA CIEGA MÉTRICA

<b>Codigo:</b> <b>155</b>	<b>Cantidad por</b> <b>caja</b>	<b>ROSCA</b> <b>MA</b>	<b>ALTURA</b>	<b>LLAVE</b>	<b>PRECIO</b> <b>(U\$S/1000)</b>
<b>001</b>	<b>2.500</b>	<b>M4- 0,70</b>	<b>8,00</b>	<b>7,00</b>	<b>846,42</b>
<b>002</b>	<b>1.500</b>	<b>M5- 0,80</b>	<b>10,00</b>	<b>8,00</b>	<b>863,51</b>
<b>003</b>	<b>1.000</b>	<b>M6- 1,00</b>	<b>12,00</b>	<b>10,00</b>	<b>965,18</b>
<b>004</b>	<b>500</b>	<b>M8- 1,25</b>	<b>15,00</b>	<b>13,00</b>	<b>1.625,70</b>
<b>005</b>	<b>250</b>	<b>M10- 1,50</b>	<b>18,50</b>	<b>17,00</b>	<b>3.044,93</b>
<b>006</b>	<b>150</b>	<b>M12- 1,75</b>	<b>21,60</b>	<b>19,00</b>	<b>5.635,63</b>
<b>007</b>	<b>100</b>	<b>M14- 2,00</b>	<b>24,00</b>	<b>22,00</b>	<b>13.099,25</b>
<b>008</b>	<b>60</b>	<b>M16- 2,00</b>	<b>27,50</b>	<b>24,00</b>	<b>17.990,96</b>

LOS PRECIOS NO INCLUYEN IVA

Actualización 19/8/2024

MOLINA ARROTEA 1150 LOMAS DE ZAMORA (1832) BS. AS.

TEL: (+54 11) 4243 5823 / 4392 4278 / 4292 0965

E-MAIL : VENTAS@TUBULON.COM.AR

WEB: WWW.TUBULON.COM.AR



MATERIAL:	ACERO INOXIDABLE AISI 316 - A4
TERMINACIÓN:	PULIDO BRILLANTE
DIMENSIONES en PULGADAS:	NORMA IFI 100
DIMENSIONES en MÉTRICAS:	NORMA DIN 985
<b>DESCUENTOS:</b>	<b>BASE DE INOXIDABLE</b>

## PRECIO DE TUERCA AUTOFRENANTE EN PULGADAS

Codigo: 158	CANTIDAD POR CAJA	ROSCA UNC - WITH	ALTURA	LLAVE	PRECIO (U\$S/1000)
002	2.000	3/16- 24	6,00	3/8	1.008,74
003	1.000	1/4- 20	8,00	7/16	1.129,78
004	600	5/16- 18	8,50	1/2	1.256,42
005	400	3/8- 16	11,50	14,00	1.726,06
007	150	1/2- 12 w	15,00	3/4	4.585,95
008	150	1/2- 13	15,00	3/4	4.585,95
010	90	5/8- 11	19,00	1 5/16	11.303,87
011	60	3/4- 10	22,00	27,00	18.216,11
012	45	7/8- 9	25,00	1 1/4	31.999,68

LOS PRECIOS NO INCLUYEN IVA

## PRECIO DE TUERCA AUTOFRENANTE MÉTRICAS

Codigo: 159	CANTIDAD POR CAJA	ROSCA MA	ALTURA	LLAVE	PRECIO (U\$S/1000)
001	3.000	M4- 0,70	5,00	7,00	971,60
002	2.500	M5- 0,80	5,00	8,00	1.004,57
003	2.000	M6- 1,00	6,00	10,00	1.041,35
004	800	M8- 1,25	8,00	13,00	1.290,84
005	350	M10- 1,50	9,50	17,00	2.230,45
006	200	M12- 1,75	12,00	19,00	2.898,42
007	150	M14- 2,00	13,60	22,00	6.281,74
008	120	M16- 2,00	16,00	24,00	6.836,94
010	60	M20-2,50	19,40	30,00	14.282,52

LOS PRECIOS NO INCLUYEN IVA

Actualización 19/8/2024

MOLINA ARROTEA 1150 LOMAS DE ZAMORA (1832) BS. AS.

TEL: (+54 11) 4243 5823 / 4392 4278 / 4292 0965

E-MAIL : VENTAS@TUBULON.COM.AR

WEB: WWW.TUBULON.COM.AR



<b>MATERIAL:</b>	<b>ACERO INOXIDABLE AISI 316 - A4</b>
<b>TERMINACIÓN:</b>	<b>PULIDO BRILLANTE</b>
<b>DIMENSIONES en PULGADAS:</b>	<b>NORMA ANSI B 18.17</b>
<b>DIMENSIONES en MÉTRICAS:</b>	<b>NORMA DIN 1587</b>
<b>DESCUENTOS:</b>	<b>BASE DE INOXIDABLE</b>

## PRECIOS DE TUERCA MARIPOSA EN PULGADAS

<b>Codigo:</b> <b>156</b>	<b>CANTIDAD POR CAJA</b>	<b>ROSCA UNC - WITH</b>	<b>ALTURA</b>	<b>LARGO ALAS</b>	<b>PRECIO (U\$\$/100)</b>
000	1.400	1/8- 40	9,00	18,50	165,70
001	1.200	5/32- 32	9,00	18,50	165,70
002	1.200	3/16- 24	10,00	22,00	175,58
003	700	1/4- 20	12,50	27,00	204,87
004	400	5/16- 18	14,00	30,00	310,48
005	300	3/8- 16	17,00	36,00	369,21
006	100	7/16- 14	23,00	48,00	1.385,71
007	100	1/2- 13	23,00	48,00	1.385,71

LOS PRECIOS NO INCLUYEN IVA

## PRECIOS DE TUERCA MARIPOSA MÉTRICAS

<b>Codigo:</b> <b>157</b>	<b>CANTIDAD POR CAJA</b>	<b>ROSCA MA</b>	<b>ALTURA</b>	<b>LARGO ALAS</b>	<b>PRECIO (U\$\$/100)</b>
000	1.200	M3- 0,50			290,10
001	1.200	M4- 0,70	9,00	19,00	290,10
002	700	M5- 0,80	10,50	22,00	356,02
003	650	M6- 1,00	13,00	27,5	382,39
004	400	M8- 1,25	14,00	30,00	514,26
005	250	M10- 1,50	17,00	30,00	692,28
006	120	M12- 1,75	23,00	48,00	2.010,88

LOS PRECIOS NO INCLUYEN IVA

Actualización 19/8/2024



<b>MATERIAL:</b>	<b>ACERO INOXIDABLE AISI 316 - A4</b>
<b>TERMINACIÓN:</b>	<b>PULIDO BRILLANTE</b>
<b>DIMENSIONES en PULGADAS:</b>	<b>NORMA IFI 136</b>
<b>DIMENSIONES en MÉTRICAS:</b>	<b>NORMA DIN 975</b>
<b>DESCUENTOS:</b>	<b>BASE DE INOXIDABLE</b>

## PRECIOS DE VARILLA ROSCADA POR METRO

<b>Codigo:</b>	<b>ROSCA</b>	<b>PRECIO</b>
<b>176</b>	<b>UNC - WITH</b>	<b>(U\$S/100)</b>
000	1/8- 40	
002	3/16- 24	903,42
003	1/4- 20	1.262,13
004	5/16- 18	1.953,19
005	3/8- 16	2.761,48
006	7/16- 14	4.009,19
007	1/2- 12 w	4.573,20
008	1/2- 13	4.573,20
009	9/16- 12	6.540,94
010	5/8- 11	7.422,71
011	3/4- 10	10.878,35
012	7/8- 9	15.431,25
013	1"- 8	18.940,15
014	1 1/8- 7	38.273,87
015	1 1/4- 7	48.466,96
017	1 1/2- 6	71.729,44

LOS PRECIOS NO INCLUYEN IVA

<b>Codigo.</b>	<b>ROSCA</b>	<b>PRECIO</b>
<b>177</b>	<b>MA</b>	<b>(U\$S/100)</b>
001	M4- 0,70	1.372,77
002	M5- 0,80	1.462,07
003	M6- 1,00	1.211,57
004	M8- 1,25	2.032,73
005	M10- 1,50	2.827,72
006	M12- 1,75	4.384,54
007	M14- 2,00	6.526,54
008	M16- 2,00	8.679,03
009	M18- 2,50	13.240,27
010	M20- 2,50	13.284,18
011	M22- 2,50	20.522,98
012	M24- 3,00	27.033,44
015	M30- 3,50	41.087,72

LOS PRECIOS NO INCLUYEN IVA

Actualización 19/8/2024



<b>MATERIAL:</b>	<b>ACERO INOXIDABLE AISI 316 - A4</b>
<b>TERMINACIÓN:</b>	<b>PULIDO BRILLANTE</b>
<b>DIMENSIONES en PULGADAS:</b>	<b>SEGÚN ESPECIFICACION</b>
<b>DIMENSIONES en MÉTRICAS:</b>	<b>NORMA DIN 125A</b>
<b>DESCUENTOS:</b>	<b>BASE DE INOXIDABLE</b>

## PRECIOS DE ARANDELA PLANA EN PULGADAS

<b>Codigo:</b> 170	<b>CANTIDAD POR CAJA</b>	<b>MEDIDA</b>	<b>DIAMETRO INTERNO</b>	<b>DIAMETRO EXTERNO</b>	<b>ESPESOR</b>	<b>PRECIO (U\$S/1000)</b>
000	5.000	1/8	3,50	10,00	1,00	108,93
001	4.500	5/32	4,00	12,00	1,00	125,26
002	3.000	3/16	5,20	13,00	1,00	138,52
003	2.000	1/4	7,00	14,00	1,50	181,78
004	1.400	5/16	9,00	18,00	1,50	275,66
005	800	3/8	10,50	20,00	1,50	442,61
006	600	7/16	12,00	24,00	2,00	556,39
007	400	1/2	14,00	27,00	2,00	640,01
009	300	9/16	16,00	30,00	2,00	1.251,42
010	200	5/8	17,00	33,00	2,50	1.665,88
011	150	3/4	20,50	40,00	3,00	2.193,38
012	130	7/8	23,50	45,00	3,00	2.497,12
013	60	1"	27,00	50,00	3,00	3.598,53
014	50	1 1/8	30,00	63,00	3,00	6.473,60
015	50	1 1/4	33,50	69,60	3,00	7.509,60
016	20	1 1/2	38,50	80,50	4,00	13.517,60

LOS PRECIOS NO INCLUYEN IVA

## PRECIOS DE ARANDELA PLANA MÉTRICAS

<b>Codigo:</b> 171	<b>CANTIDAD POR CAJA</b>	<b>MEDIDA</b>	<b>DIAMETRO INTERNO</b>	<b>DIAMETRO EXTERNO</b>	<b>ESPESOR</b>	<b>PRECIO (U\$S/1000)</b>
000	20.000	M3	3,40	6,50	0,50	53,77
001	5.500	M4	4,50	9,00	0,80	78,42
002	5.000	M5	5,50	9,50	1,00	82,22
003	2.500	M6	6,50	11,50	1,50	160,62
004	1.500	M8	8,40	16,00	1,50	246,93
005	1.000	M10	10,50	20,00	2,00	508,09
006	350	M12	13,00	23,50	2,50	857,34
007	250	M14	15,00	27,00	2,50	1.221,69
008	200	M16	17,00	29,00	3,00	1.566,61
010	100	M20	21,00	36,50	3,00	2.413,40
011	90	M22	24,00	38,00	3,00	3.016,00
012	90	M24	25,00	43,90	3,30	3.836,00

LOS PRECIOS NO INCLUYEN IVA

Actualización 19/8/2024



<b>MATERIAL:</b>	<b>ACERO INOXIDABLE AISI 316 - A4</b>
<b>TERMINACIÓN:</b>	<b>PULIDO BRILLANTE</b>
<b>DIMENSIONES en PULGADAS:</b>	<b>SEGÚN ESPECIFICACION</b>
<b>DIMENSIONES en MÉTRICAS:</b>	<b>NORMA DIN 125A</b>
<b>DESCUENTOS:</b>	<b>BASE DE INOXIDABLE</b>

## PRECIO DE ARANDELA CHAPISTA EN PULGADAS

<b>Codigo:</b> 172	<b>CANTIDAD POR CAJA</b>	<b>MEDIDA</b>	<b>DIAMETRO INTERNO</b>	<b>DIAMETRO EXTERNO</b>	<b>ESPESOR</b>	<b>PRECIO (U\$/1000)</b>
002	700	3/16	5,00	25	1,50	319,37
003	600	1/4	7,00	28	2,00	534,34
004	400	5/16	8,70	32	2,00	685,15
005	250	3/8	10,50	38	2,00	994,94
006	200	7/16	11,50	47	2,00	1.736,54
007	150	1/2	14,00	44	3,00	1.499,45
010	100	5/8	17,00	50	3,00	1.973,66

LOS PRECIOS NO INCLUYEN IVA

## PRECIO DE ARANDELA CHAPISTA MÉTRICA

<b>Codigo:</b> 173	<b>CANTIDAD POR CAJA</b>	<b>MEDIDA</b>	<b>DIAMETRO INTERNO</b>	<b>DIAMETRO EXTERNO</b>	<b>ESPESOR</b>	<b>PRECIO (U\$/1000)</b>
001	4.500	M4	4,50	12	1,0	143,03
002	3.500	M5	5,30	15	1,2	232,98
003	1.700	M6	6,40	18	1,6	370,73
004	800	M8	8,40	24	2,0	894,98
005	400	M10	10,50	30	2,5	1.640,96
006	250	M12	13,00	37	3,0	2.911,19
008	100	M16	17,00	50	3,0	5.188,34

LOS PRECIOS NO INCLUYEN IVA

Actualización 19/8/2024



MOLINA ARROTEA 1150 LOMAS DE ZAMORA (1832) BS. AS.

TEL: (+54 11) 4243 5823 / 4392 4278 / 4292 0965

E-MAIL : VENTAS@TUBULON.COM.AR

WEB: WWW.TUBULON.COM.AR



## PRECIOS DE ARANDELA GROWER

<b>MATERIAL:</b>	<b>ACERO INOXIDABLE AISI 316 - A4</b>
<b>TERMINACIÓN:</b>	<b>PULIDO BRILLANTE</b>
<b>DIMENSIONES en PULGADAS:</b>	<b>SEGÚN ESPECIFICACION</b>
<b>DIMENSIONES en MÉTRICAS:</b>	<b>NORMA DIN 127</b>
<b>DESCUENTOS:</b>	<b>BASE DE INOXIDABLE</b>

<b>Codigo:</b> <b>174</b>	<b>CANTIDAD POR CAJA</b>	<b>MEDIDA</b>	<b>PRECIO (U\$S/1000)</b>
000	14.000	1/8	128,53
001	9.000	5/32	124,17
002	5.000	3/16	154,98
003	2.000	1/4	176,42
004	1.000	5/16	237,57
005	800	3/8	371,02
006	500	7/16	480,74
007	400	1/2	619,88
009	300	9/16	910,81
010	250	5/8	1.325,76
011	130	3/4	2.180,35
012	100	7/8	2.530,71
013	50	1"	4.081,50
014	40	1 1/8	4.733,60
015	35	1 1/4	5.490,40
016	20	1 1/2	11.528,80

LOS PRECIOS NO INCLUYEN IVA

<b>Codigo:</b> <b>175</b>	<b>CANTIDAD POR CAJA</b>	<b>MEDIDA</b>	<b>PRECIO (U\$S/1000)</b>
001	8.000	M4	
003	2.000	M6	
005	800	M10	463,77
006	400	M12	745,63
010	100	M20	2.845,00

LOS PRECIOS NO INCLUYEN IVA

Actualización 19/8/2024



MATERIAL:	ACERO INOXIDABLE AISI 316 - A4
TERMINACIÓN:	PULIDO BRILLANTE
DIMENSIONES en PULGADAS:	NORMA ANSI B18.2.1
ROSCA:	PASO UNC y WITHWORTH
<b>DESCUENTOS:</b>	<b>BASE DE INOXIDABLE</b>

## PRECIOS DE BULÓN HEXAGONAL EN PULGADAS (U\$S/100)

ROSCA / LARGO	3/16- 24 x	1/4- 20 x	5/16- 18 x	3/8- 16 x	7/16- 14 x	1/2- 12 x	1/2- 13 x	9/16- 12 x	5/8- 11 x	3/4- 10 x	7/8- 9 x	1"- 8 x
Codigo: 185												
3/8	085 60,79											
1/2	086 60,79	126 60,79	166 99,45	206 117,53								
5/8	087 65,31	127 65,31	167 107,88	207 129,57								
3/4	088 70,16	128 70,16	168 116,35	208 139,63	248 273,44							
7/8	089 75,13	129 75,13	169 123,60	209 147,30								
1"	090 81,27	130 81,27	170 132,28	210 161,32	250 272,67	290 403,63	330 403,63	370 633,71	410 723,29			
1 1/4	091 95,46	131 95,46	171 152,92	211 181,45	251 317,75	291 444,30	331 444,30	371 667,25	411 789,29			
1 1/2	092 111,07	132 111,07	172 176,28	212 207,33	252 364,77	292 496,63	332 496,63	372 700,11	412 841,96	452 1387,69		
1 3/4	093 124,33	133 124,33	173 200,05	213 233,81	253 411,06	293 529,18	333 529,18	373 811,42	413 926,14	453 1463,51		
2"	094 141,12	134 141,12	174 205,49	214 273,05	254 458,49	294 612,94	334 612,94	374 956,33	414 1004,01	454 1578,71		
2 1/4	095 0,00	135 144,70		215 290,00		295 641,01						
2 1/2	096 146,33	136 146,33	176 268,93	216 294,33	256 553,19	296 669,09	336 669,09	376 1091,25	416 1188,93	456 1729,86	496 2651,88	536 3915,55
2 3/4									417 1285,30			
3"	098 181,48	138 181,48	178 314,17	218 370,25	258 646,22	298 764,68	338 764,68	378 1224,74	418 1362,98	458 2099,87	498 3119,36	538 4313,63
3 1/2		139 201,54	179 320,73	219 427,78	259 740,19	299 973,34	339 973,34	379 1467,53	419 1539,60	459 2380,66	499 3447,58	539 4976,57
4"		140 230,06	180 378,92	220 452,77	260 846,68	300 976,01	340 976,01	380 1624,17	420 1693,71	460 2668,43	500 3957,71	540 5260,80
4 1/2			181 454,71	221 538,82	261 1058,35	301 1226,44			421 2013,54	461 2811,98	501 4353,08	541 5897,23
5"			182 500,17	222 597,67	262 1164,19	302 1350,14			422 2195,82	462 3340,12	502 4679,26	542 6488,03
5 1/2			183 550,17	223 657,43	263 1280,60	303 1482,66			423 2519,84	463 3838,24	503 5021,65	543 6992,02
6"			184 605,20	224 723,18	264 1408,68	304 1592,97			424 2897,45	464 4415,05	504 5414,62	544 7588,20

LOS PRECIOS NO INCLUYEN IVA

Actualización

19/8/2024

## BULÓN HEXAGONAL EN PULGADAS - CANTIDAD POR CAJA

ROSCA / LARGO	3/16- 24 x	1/4- 20 x	5/16- 18 x	3/8- 16 x	7/16- 14 x	1/2- 12 x	1/2- 13 x	9/16- 12 x	5/8- 11 x	3/4- 10 x	7/8- 9 x	1"- 8 x
<b>Codigo: 185</b>												
<b>3/8</b>	085 1.500											
<b>1/2</b>	086 1.200	126 800	166 400	206 300								
<b>5/8</b>	087 1.000	127 600	167 300	207 250								
<b>3/4</b>	088 800	128 600	168 300	208 250	248 200							
<b>7/8</b>	089 700	129 600	169 300	209 200								
<b>1"</b>	090 600	130 500	170 250	210 200	250 150	290 100	330 100	370 100	410 50			
<b>1 1/4</b>	091 500	131 400	171 200	211 150	251 100	291 80	331 80	371 80	411 50			
<b>1 1/2</b>	092 500	132 300	172 200	212 150	252 100	292 75	332 75	372 80	412 40	452 25		
<b>1 3/4</b>	093 400	133 300	173 150	213 100	253 80	293 50	333 50	373 70	413 30	453 25		
<b>2"</b>	094 350	134 300	174 150	214 100	254 70	294 50	334 50	374 65	414 30	454 21		
<b>2 1/4</b>	095 300	135 250		215 100		295 50						
<b>2 1/2</b>	096 250	136 200	176 100	216 100	256 65	296 50	336 50	376 60	416 30	456 16	496 15	536 14
<b>2 3/4</b>									417 30			
<b>3"</b>	098 200	138 150	178 100	218 90	258 50	298 45	338 45	378 45	418 24	458 15	498 15	538 10
<b>3 1/2</b>		139 150	179 100	219 75	259 50	299 32	339 32	379 40	419 24	459 15	499 12	539 10
<b>4"</b>		140 150	180 100	220 75	260 50	300 30	340 30	380 35	420 20	460 15	500 12	540 8
<b>4 1/2</b>			181 90	221 70	261 50	301 35			421 20	461 15	501 10	541 8
<b>5"</b>			182 75	222 50	262 45	302 35			422 20	462 15	502 10	542 8
<b>5 1/2</b>			183 75	223 50	263 45	303 30			423 20	463 15	503 10	543 8
<b>6"</b>			184 75	224 50	264 45	304 30			424 18	464 12	504 9	544 6

LOS PRECIOS NO INCLUYEN IVA

Actualización

19/8/2024



<b>MATERIAL:</b>	<b>ACERO INOXIDABLE AISI 316 - A4</b>
<b>TERMINACIÓN:</b>	<b>PULIDO BRILLANTE</b>
<b>DIMENSIONES en MÉTRICAS:</b>	<b>NORMA DIN 933 - DIN 931 (C/CUELLO)</b>
<b>ROSCA:</b>	<b>PASO MA</b>
<b>DESCUENTOS:</b>	<b>BASE DE INOXIDABLE</b>

## PRECIOS DE BULÓN HEXAGONAL MÉTRICO (U\$S/100)

ROSCA / LARGO	M4- 0,70 x	M5- 0,80 x	M6- 1,00 x	M8- 1,25 x	M10- 1,50 x	M12- 1,75 x	M14- 2,00 x	M16- 2,00 x	M20- 2,50 x
<b>Codigo: 186</b>									
8 mm	044 41,66								
10 mm	045 43,31	085 43,31	125 49,62						
12 mm	046 48,75	086 48,75	126 52,05	166 106,67					
16 mm	047 51,88	087 51,88	127 55,90	167 115,10	207 205,53				
20 mm	048 58,54	088 58,54	128 60,23	168 124,71	208 226,63	248 331,14			
25 mm	049 67,53	089 67,53	129 67,01	169 137,31	209 238,42	249 336,80			
30 mm	050 73,81	090 73,81	130 74,78	170 146,85	210 270,10	250 374,55	290 643,65	330 790,88	
35 mm	051 82,20	091 82,20	131 83,49	171 164,24	211 282,25	251 406,96	291 680,15	331 807,26	
40 mm	052 90,84	092 90,84	132 97,99	172 178,74	212 305,19	252 443,05	292 733,00	332 872,01	412 1471,70
45 mm	053 99,65	093 99,66	133 100,01	173 193,21	213 329,03	253 483,82	293 783,01	333 938,77	413 1593,15
50 mm	054 106,42	094 106,42	134 109,69	174 210,63	214 354,74	254 507,52	294 847,83	334 997,73	414 1700,16
60 mm			136 126,20	176 241,51	216 400,54	256 585,28	296 949,46	336 1131,15	416 1898,02
70 mm			138 153,17	178 270,49	218 446,31	258 653,89	298 1059,56	338 1256,83	418 2096,82
80 mm			140 160,35	180 297,00	220 500,69	260 721,93	300 1164,50	340 1392,16	420 2299,36
90 mm			142 178,84	182 334,30	222 548,33	262 789,88	302 1274,32	342 1517,88	422 2492,29
100 mm			144 189,50	184 362,30	224 603,64	264 858,55	304 1381,86	344 1643,53	424 2696,05
110 mm				185 454,88	225 664,05	265 892,62	305 1451,50	345 1952,95	425 3092,08
120 mm				186 500,37	226 730,47	266 968,93	306 1527,67	346 2107,64	426 3327,11
130 mm				187 550,37	227 803,51	267 1040,06	307 1615,63	347 2223,65	427 3448,94
140 mm				188 605,41	228 883,88	268 1113,73	308 1717,82	348 2269,66	428 3575,31
150 mm				189 665,93	229 972,25	269 1187,43	309 1819,98	349 2417,31	429 3888,13

LOS PRECIOS NO INCLUYEN IVA

Actualización 19/8/2024

## BULÓN HEXAGONAL MÉTRICO - CANTIDAD POR CAJA

ROSCA / LARGO	M4- 0,70 x	M5- 0,80 x	M6- 1,00 x	M8- 1,25 x	M10- 1,50 x	M12- 1,75 x	M14- 2,00 x	M16- 2,00 x	M20- 2,50 x
<b>Codigo: 186</b>									
8 mm	044 2.000								
10 mm	045 1.500	085 900	125 800						
12 mm	046 1.500	086 800	126 800	166 500					
16 mm	047 1.500	087 600	127 600	167 350	207 200				
20 mm	048 1.000	088 600	128 600	168 300	208 200	248 150			
25 mm	049 800	089 500	129 500	169 300	209 200	249 100			
30 mm	050 700	090 450	130 450	170 200	210 150	250 100	290 80	330 60	
35 mm	051 500	091 400	131 400	171 200	211 150	251 80	291 80	331 50	
40 mm	052 500	092 350	132 350	172 200	212 100	252 75	292 70	332 50	412 30
45 mm	053 400	093 300	133 300	173 150	213 100	253 75	293 65	333 45	413 20
50 mm	054 300	094 300	134 300	174 150	214 100	254 75	294 60	334 40	414 20
60 mm			136 200	176 100	216 70	256 50	296 45	336 35	416 20
70 mm			138 150	178 100	218 50	258 45	298 40	338 35	418 20
80 mm			140 150	180 100	220 50	260 30	300 35	340 30	420 15
90 mm			142 150	182 100	222 50	262 30	302 35	342 25	422 15
100 mm			144 100	184 100	224 50	264 30	304 30	344 25	424 15
110 mm				185 90	225 50	265 30	305 30	345 20	425 15
120 mm				186 75	226 50	266 30	306 30	346 20	426 15
130 mm				187 75	227 50	267 30	307 30	347 20	427 12
140 mm				188 75	228 50	268 30	308 25	348 20	428 12
150 mm				189 75	229 50	269 25	309 25	349 15	429 10

LOS PRECIOS NO INCLUYEN IVA

Actualización 19/8/2024



MATERIAL:	ACERO INOXIDABLE AISI 316 - A4
TERMINACIÓN:	PULIDO BRILLANTE
DIMENSIONES en PULGADAS:	NORMA ASME B18.2
ROSCA:	PASO UNC y WITHWORTH
<b>DESCUENTOS:</b>	<b>BASE DE INOXIDABLE</b>

### PRECIOS DE ALLEN CABEZA CILÍNDRICA EN PULGADAS (U\$S/100)

ROSCA / LARGO	3/16- 24 x	1/4- 20 x	5/16- 18 x	3/8- 16 x	1/2- 12 x	1/2- 13 x	5/8- 11 x	3/4- 10 x
<b>Codigo: 190</b>								
3/8	<sup>085</sup> 75,99	<sup>125</sup> 119,23						
1/2	<sup>086</sup> 84,18	<sup>126</sup> 101,95	<sup>166</sup> 162,12	<sup>206</sup> 262,75				
5/8	<sup>087</sup> 87,24	<sup>127</sup> 113,12	<sup>167</sup> 179,47	<sup>207</sup> 287,73				
3/4	<sup>088</sup> 97,09	<sup>128</sup> 125,13	<sup>168</sup> 196,12	<sup>208</sup> 305,64		<sup>328</sup> 826,42		
7/8	<sup>089</sup> 99,17	<sup>129</sup> 134,71	<sup>169</sup> 213,27	<sup>209</sup> 332,08		<sup>329</sup> 876,24		
1"	<sup>090</sup> 103,89	<sup>130</sup> 146,43	<sup>170</sup> 225,20	<sup>210</sup> 353,87	<sup>290</sup> 1476,83	<sup>330</sup> 929,34	<sup>410</sup> 2322,00	
1 1/4	<sup>091</sup> 126,31	<sup>131</sup> 183,98	<sup>171</sup> 266,70	<sup>211</sup> 413,00		<sup>331</sup> 1043,71	<sup>411</sup> 2607,00	
1 1/2	<sup>092</sup> 154,35	<sup>132</sup> 203,76	<sup>172</sup> 313,41	<sup>212</sup> 489,06		<sup>332</sup> 1169,46	<sup>412</sup> 2922,00	
1 3/4	<sup>093</sup> 186,96	<sup>133</sup> 232,91	<sup>173</sup> 358,17	<sup>213</sup> 539,72		<sup>333</sup> 1294,17	<sup>413</sup> 3235,00	
2"	<sup>094</sup> 220,21	<sup>134</sup> 262,75	<sup>174</sup> 402,80	<sup>214</sup> 602,67		<sup>334</sup> 1447,06	<sup>414</sup> 3617,00	
2 1/4	<sup>095</sup> 250,12	<sup>135</sup> 299,60	<sup>175</sup> 459,43	<sup>215</sup> 688,03		<sup>335</sup> 1607,10	<sup>415</sup> 4338,00	
2 1/2	<sup>096</sup> 304,74	<sup>136</sup> 339,30	<sup>176</sup> 487,05	<sup>216</sup> 785,40		<sup>336</sup> 1729,24	<sup>416</sup> 4668,00	
2 3/4	<sup>097</sup> 383,44	<sup>137</sup> 397,00	<sup>177</sup> 554,30	<sup>217</sup> 909,28		<sup>337</sup> 1875,33	<sup>417</sup> 5062,00	
3"	<sup>098</sup> 454,40	<sup>138</sup> 476,00	<sup>178</sup> 633,97	<sup>218</sup> 1048,91		<sup>338</sup> 2011,49	<sup>418</sup> 5429,00	
3 1/2						<sup>339</sup> 2273,61	<sup>419</sup> 6137,00	<sup>459</sup> 11950,68

LOS PRECIOS NO INCLUYEN IVA

Actualización 19/8/2024

### ALLEN CABEZA CILÍNDRICA - CANTIDAD POR CAJA

ROSCA / LARGO	3/16- 24 x	1/4- 20 x	5/16- 18 x	3/8- 16 x	1/2- 12 x	1/2- 13 x	5/8- 11 x	3/4- 10 x
<b>Codigo: 190</b>								
3/8	<sup>085</sup> 1.100	<sup>125</sup> 700						
1/2	<sup>086</sup> 1.000	<sup>126</sup> 1.000	<sup>166</sup> 500	<sup>206</sup> 300				
5/8	<sup>087</sup> 800	<sup>127</sup> 800	<sup>167</sup> 400	<sup>207</sup> 250				
3/4	<sup>088</sup> 700	<sup>128</sup> 600	<sup>168</sup> 350	<sup>208</sup> 250		<sup>328</sup> 120		
7/8	<sup>089</sup> 600	<sup>129</sup> 500	<sup>169</sup> 300	<sup>209</sup> 200		<sup>329</sup> 100		
1"	<sup>090</sup> 600	<sup>130</sup> 500	<sup>170</sup> 300	<sup>210</sup> 200	<sup>290</sup> 100	<sup>330</sup> 100	<sup>410</sup> 40	
1 1/4	<sup>091</sup> 500	<sup>131</sup> 450	<sup>171</sup> 250	<sup>211</sup> 150		<sup>331</sup> 80	<sup>411</sup> 35	
1 1/2	<sup>092</sup> 400	<sup>132</sup> 400	<sup>172</sup> 200	<sup>212</sup> 150		<sup>332</sup> 80	<sup>412</sup> 35	
1 3/4	<sup>093</sup> 350	<sup>133</sup> 300	<sup>173</sup> 200	<sup>213</sup> 100		<sup>333</sup> 75	<sup>413</sup> 30	
2"	<sup>094</sup> 300	<sup>134</sup> 300	<sup>174</sup> 200	<sup>214</sup> 100		<sup>334</sup> 50	<sup>414</sup> 30	
2 1/4	<sup>095</sup> 300	<sup>135</sup> 300	<sup>175</sup> 200	<sup>215</sup> 100		<sup>335</sup> 50	<sup>415</sup> 25	
2 1/2	<sup>096</sup> 250	<sup>136</sup> 300	<sup>176</sup> 150	<sup>216</sup> 100		<sup>336</sup> 50	<sup>416</sup> 25	
2 3/4	<sup>097</sup> 200	<sup>137</sup> 250	<sup>177</sup> 150	<sup>217</sup> 100		<sup>337</sup> 50	<sup>417</sup> 20	
3"	<sup>098</sup> 200	<sup>138</sup> 250	<sup>178</sup> 150	<sup>218</sup> 100		<sup>338</sup> 45	<sup>418</sup> 20	
3 1/2						<sup>339</sup> 40	<sup>419</sup> 15	<sup>459</sup> 15

LOS PRECIOS NO INCLUYEN IVA

24/9/2024

Actualización 19/8/2024



MATERIAL:	ACERO INOXIDABLE AISI 316 - A4
TERMINACIÓN:	PULIDO BRILLANTE
DIMENSIONES en MÉTRICAS:	NORMA DIN 912
ROSCA:	PASO MA
DESCUENTOS:	BASE DE INOXIDABLE

### PRECIOS DE ALLEN CABEZA CILÍNDRICA MÉTRICO (U\$S/100)

ROSCA / LARGO	M3- 0,50 x	M4- 0,70 x	M5- 0,80 x	M6- 1,00 x	M8- 1,25 x	M10- 1,50 x	M12- 1,75 x	M16- 2,00 x
<b>Codigo: 191</b>								
6 mm	003 100,22							
8 mm	004 103,18	044 114,65						
10 mm	005 80,56	045 89,50	085 118,70	125 116,10				
12 mm	006 86,25	046 95,82	086 97,94	126 118,03	166 233,46			
16 mm	007 98,41	047 110,87	087 105,15	127 117,09	167 259,39	207 417,18		
20 mm	008 108,74	048 120,81	088 112,98	128 129,70	168 268,10	208 435,06	248 760,51	
25 mm	009 122,03	049 135,58	089 116,98	129 142,24	169 277,49	209 472,75	249 755,13	
30 mm	010 142,16	050 157,95	090 131,64	130 183,44	170 283,82	210 500,02	250 817,09	330 2042,02
35 mm	011 161,01		091 156,74	131 204,98	171 314,74	211 520,34	251 884,88	331 2108,10
40 mm	012 180,38		092 176,17	132 221,69	172 376,48	212 557,20	252 951,50	332 2163,84
45 mm	013 203,92		093 203,59	133 246,84	173 413,02	213 635,87	253 1055,82	333 2482,63
50 mm	014 239,23		094 232,02	134 275,05	174 432,39	214 720,42	254 1153,76	334 2718,37
60 mm					176 512,01	216 924,41	256 1279,29	336 3007,02
70 mm					178 591,12	218 1088,53	258 1445,80	338 3647,94
80 mm					180 680,73	220 1129,55	260 1716,85	340 3961,74
90 mm								
100 mm							264 2588,01	

LOS PRECIOS NO INCLUYEN IVA

Actualización 19/8/2024

### ALLEN CABEZA CILÍNDRICA MÉTRICO - CANTIDAD POR CAJA

ROSCA / LARGO	M3- 0,50 x	M4- 0,70 x	M5- 0,80 x	M6- 1,00 x	M8- 1,25 x	M10- 1,50 x	M12- 1,75 x	M16- 2,00 x
<b>Codigo: 191</b>								
6 mm	003 4.000							
8 mm	004 3.500	044 1.500						
10 mm	005 3.400	045 1.500	085 900	125 600				
12 mm	006 3.000	046 1.500	086 800	126 600	166 500			
16 mm	007 2.300	047 1.000	087 800	127 600	167 300	207 200		
20 mm	008 1.900	048 1.000	088 700	128 600	168 300	208 200	248 150	
25 mm	009 1.400	049 800	089 600	129 500	169 300	209 150	249 100	
30 mm	010 1.100	050 600	090 500	130 450	170 200	210 150	250 100	330 50
35 mm	011 950		091 400	131 400	171 200	211 150	251 80	331 50
40 mm	012 800		092 350	132 350	172 200	212 100	252 75	332 45
45 mm	013 650		093 300	133 300	173 150	213 100	253 75	333 40
50 mm	014 500		094 250	134 300	174 150	214 100	254 75	334 40
60 mm					176 100	216 70	256 50	336 35
70 mm					178 100	218 50	258 45	338 35
80 mm					180 100	220 50	260 40	340 30
90 mm								
100 mm				24/9/2024			264 40	

LOS PRECIOS NO INCLUYEN IVA

Actualización 19/8/2024



MATERIAL:	ACERO INOXIDABLE AISI 316 - A4
TERMINACIÓN:	PULIDO BRILLANTE
DIMENSIONES:	ASME B18.3
TIPO DE ROSCA:	NORMA UNC - WITH
<b>DESCUENTOS:</b>	<b>BASE DE INOXIDABLE</b>

**PRECIOS DE ALLEN CABEZA FREZADA EN PULGADAS (U\$S/100)**

ROSCA / LARGO	3/16- 24 x	1/4- 20 x	5/16- 18 x	3/8- 16 x
<b>Codigo: 192</b>				
3/8	81,03	110,18		
1/2	85,40	111,35	155,65	343,74
5/8	90,01	118,05	168,47	348,42
3/4	93,69	125,33	174,95	352,69
7/8	96,48	128,83	186,49	382,78
1"	96,48	134,66	194,71	394,66
1 1/4	108,43	145,61	213,65	426,73
1 1/2	113,68	154,48	228,52	465,79
1 3/4	127,67	173,14	253,30	513,01
2"	132,33	184,51	273,93	548,57
2 1/4	154,61	198,08	295,27	601,91
2 1/2	184,80	203,98	381,77	658,16
2 3/4	197,06	239,84	492,47	784,00
3"	205,20	264,43	526,54	816,14

LOS PRECIOS NO INCLUYEN IVA

Actualización

19/8/2024

**ALLEN CABEZA FREZADA EN PULGADAS - CANTIDAD POR CAJA**

ROSCA / LARGO	3/16- 24 x	1/4- 20 x	5/16- 18 x	3/8- 16 x
<b>Codigo: 192</b>				
3/8	1.400	1.000		
1/2	1.250	800	400	300
5/8	1.100	700	350	250
3/4	950	500	350	200
7/8	800	450	300	150
1"	700	400	250	150
1 1/4	600	350	200	100
1 1/2	500	300	150	100
1 3/4	400	250	150	100
2"	300	200	150	100
2 1/4	300	200	100	80
2 1/2	250	150	100	80
2 3/4	250	150	100	70
3"	200	150	100	50

24/9/2024







MATERIAL:	ACERO INOXIDABLE AISI 316 - A4
TERMINACIÓN:	PULIDO BRILLANTE
DIMENSIONES:	NORMA DIN 7991
ROSCA:	PASO MA
DESCUENTOS:	BASE DE INOXIDABLE

### PRECIOS ALLEN CABEZA FREZADA MÉTRICO (U\$S/100)

ROSCA / LARGO	M3- 0,50 x	M4- 0,70 x	M5- 0,80 x	M6- 1,00 x	M8- 1,25 x	M10- 1,50 x	M12- 1,75 x
Codigo: 193							
6 mm	003 76,09						
8 mm	004 80,36						
10 mm	005 84,82	045 84,82	085 89,73	125 77,78			
12 mm	006 98,58	046 98,58	086 85,90	126 85,90			
16 mm	007 105,18	047 105,18	087 82,82	127 90,73	167 210,00		
20 mm	008 114,59	048 114,59	088 93,11	128 106,93	168 226,15	208 375,76	248 776,71
25 mm	009 125,13	049 125,13	089 112,22	129 117,34	169 237,18	209 395,41	249 527,75
30 mm	010 139,07	050 139,07	090 127,79	130 129,29	170 260,04	210 412,15	250 553,36
35 mm			091 153,36	131 155,36	171 281,61	211 440,89	251 602,15
40 mm			092 184,03	132 183,01	172 353,39	212 476,53	252 670,99
45 mm			093 207,00	133 198,54	173 377,59	213 576,55	253 740,44
50 mm				134 219,65	174 406,87	214 602,11	254 795,66
60 mm				136 262,54	176 492,40	216 722,54	256 952,28
70 mm				138 330,87	178 585,88	218 1.279,28	258 1.142,74
80 mm							

LOS PRECIOS NO INCLUYEN IVA

Actualización 19/8/2024

### ALLEN CABEZA FREZADA MÉTRICO - CANTIDAD POR CAJA

ROSCA / LARGO	M3- 0,50 x	M4- 0,70 x	M5- 0,80 x	M6- 1,00 x	M8- 1,25 x	M10- 1,50 x	M12- 1,75 x
Codigo: 193							
6 mm	003 8.000						
8 mm	004 5.000						
10 mm	005 5.000	045 2.000	085 1.500	125 1.900			
12 mm	006 3.500	046 2.000	086 1.000	126 900			
16 mm	007 2.500	047 1.500	087 800	127 750	167 400		
20 mm	008 2.000	048 1.000	088 750	128 500	168 300	208 150	248 100
25 mm	009 1.500	049 1.000	089 500	129 400	169 250	209 150	249 100
30 mm	010 1.300	050 800	090 500	130 350	170 200	210 150	250 100
35 mm			091 400	131 300	171 150	211 100	251 80
40 mm			092 400	132 250	172 150	212 100	252 70
45 mm			093 300	133 200	173 150	213 80	253 60
50 mm				134 200	174 150	214 80	254 50
60 mm				136 150	176 100	216 50	256 50
70 mm				138 120	178 75	218 50	258 40
80 mm							

LOS PRECIOS NO INCLUYEN IVA

24/9/2024

Actualización 19/8/2024



MATERIAL:	ACERO INOXIDABLE AISI 316 - A4
TERMINACIÓN:	PULIDO BRILLANTE
DIMENSIONES:	NORMA ASME B18.6.3
ROSCA:	PASO UNC y WITHWORTH
<b>DESCUENTOS:</b>	<b>BASE DE INOXIDABLE</b>

**PRECIOS TORNILLO CABEZA REDONDA EN PULGADAS (U\$S/100)**

ROSCA / LARGO	1/8- 40 x	5/32- 32 x	3/16- 24 x	1/4- 20 x	5/16- 18 x	3/8- 16 x
<b>Codigo: 200</b>						
3/16	59,02					
1/4	62,26	63,52	46,47			
5/16	63,15	63,40	48,17			
3/8	64,61	64,86	50,89	62,01		
1/2	65,46	65,90	52,30	66,38	140,40	
5/8	66,63	66,99	54,73	70,44	149,82	
3/4	66,50	68,86	57,88	75,78	162,58	310,07
7/8	69,18	69,59	59,47	78,53	169,06	320,33
1"	71,05	71,29	62,62	83,63	181,81	341,03
1 1/4	79,99	80,28	67,72	91,57	200,83	384,15
1 1/2	82,90	83,27	72,63	99,59	213,75	402,97
1 3/4	85,50	85,82	80,64	108,93	242,90	439,40
2"	87,64	87,79	85,33	116,78	264,52	470,36
2 1/4		114,04	89,94	124,24	280,43	501,35
2 1/2		136,87	95,41	134,20	302,53	537,49
2 3/4		164,28	99,95	142,09	361,99	568,46
3"		197,06	104,57	149,86	383,37	599,43

LOS PRECIOS NO INCLUYEN IVA

Actualización

19/8/2024

**TORNILLO CABEZA REDONDA - CANTIDAD POR CAJA**

ROSCA / LARGO	1/8- 40 x	5/32- 32 x	3/16- 24 x	1/4- 20 x	5/16- 18 x	3/8- 16 x
<b>Codigo: 200</b>						
3/16	2.500					
1/4	2.400	2.100	1.700			
5/16	2.200	1.900	1.500			
3/8	2.000	1.800	1.400	850		
1/2	1.800	1.600	1.250	700	400	
5/8	1.700	1.500	1.100	600	350	
3/4	1.600	1.400	950	500	350	200
7/8	1.500	1.200	800	450	300	150
1"	1.300	1.000	700	400	250	150
1 1/4	1.100	800	600	350	200	100
1 1/2	900	600	500	300	150	100
1 3/4	700	500	400	250	150	100
2"	500	400	300	200	150	100
2 1/4		400	300	200	100	50
2 1/2		350	250	150	100	50
2 3/4		350	250	150	100	50
3"		350	250	150	100	50

LOS PRECIOS NO INCLUYEN IVA

24/9/2024

Actualización

19/8/2024



MATERIAL:	ACERO INOXIDABLE AISI 316 - A4
TERMINACIÓN:	PULIDO BRILLANTE
DIMENSIONES:	NORMA ASME B18.6.3
ROSCA:	PASO UNC y WITHWORTH
DESCUENTOS:	BASE DE INOXIDABLE

**PRECIOS TORNILLO CABEZA FREZADA R/POZIDRIVE (U\$S/100)**

ROSCA / LARGO	1/8- 40 x	5/32- 32 x	3/16- 24 x	1/4- 20 x	5/16- 18 x	3/8- 16 x
<b>Codigo: 201</b>						
3/16	002 59,02					
1/4	003 44,47	043 45,37	083 33,19			
5/16	004 45,11	044 45,29	084 34,41			
3/8	005 46,15	045 46,33	085 36,35	125 44,29		
1/2	006 46,76	046 47,07	086 37,36	126 47,42	166 100,29	
5/8	007 47,59	047 47,85	087 39,09	127 50,32	167 107,02	
3/4	008 48,93	048 49,19	088 41,35	128 54,13	168 116,13	208 221,48
7/8	009 49,42	049 49,71	089 42,48	129 56,09	169 120,76	209 228,81
1"	010 50,75	050 50,92	090 44,73	130 59,74	170 129,87	210 243,60
1 1/4	011 57,14	051 57,34	091 48,37	131 65,41	171 143,45	211 274,39
1 1/2	012 59,22	052 59,48	092 51,88	132 71,14	172 152,68	212 287,84
1 3/4	013 61,07	053 61,30	093 57,60	133 77,81	173 173,50	213 313,86
2"	014 62,60	054 62,69	094 60,95	134 83,42	174 188,94	214 335,99
2 1/4		055 81,46	095 64,25	135 88,75	175 200,31	215 358,11
2 1/2		056 97,77	096 68,15	136 95,86	176 216,10	216 383,92
2 3/4		057 117,34	097 71,40	137 101,50	177 258,57	217 406,04
3"		058 140,76	098 74,69	138 107,05	178 273,84	218 428,17

LOS PRECIOS NO INCLUYEN IVA

Actualización

19/8/2024

**TORNILLO CABEZA FREZADA RANURA POZIDRIVE - CANTIDAD POR CAJA**

ROSCA / LARGO	1/8- 40 x	5/32- 32 x	3/16- 24 x	1/4- 20 x	5/16- 18 x	3/8- 16 x
<b>Codigo: 201</b>						
3/16	002 2.500					
1/4	003 2.400	043 2.100	083 1.700			
5/16	004 2.200	044 1.900	084 1.500			
3/8	005 2.000	045 1.800	085 1.400	125 850		
1/2	006 1.800	046 1.600	086 1.250	126 700	166 400	
5/8	007 1.700	047 1.500	087 1.100	127 600	167 350	
3/4	008 1.600	048 1.400	088 950	128 500	168 350	208 200
7/8	009 1.500	049 1.200	089 800	129 450	169 300	209 150
1"	010 1.300	050 1.000	090 700	130 400	170 250	210 150
1 1/4	011 1.100	051 800	091 600	131 350	171 200	211 100
1 1/2	012 900	052 600	092 500	132 300	172 150	212 100
1 3/4	013 700	053 500	093 400	133 250	173 150	213 100
2"	014 500	054 400	094 300	134 200	174 150	214 100
2 1/4		055 400	095 300	135 200	175 100	215 50
2 1/2		056 350	096 250	136 150	176 100	216 50
2 3/4		057 350	097 250	137 150	177 100	217 50
3"		058 350	098 250	138 150	178 100	218 50

LOS PRECIOS NO INCLUYEN IVA

24/9/2024

Actualización

19/8/2024



MATERIAL:	ACERO INOXIDABLE AISI 316 - A4
TERMINACION:	PULIDO BRILLANTE
DIMENSIONES:	NORMA DIN 965
ROSCA:	PASO MA
DESCUENTOS:	BASE DE INOXIDABLE

### PRECIOS TORNILLO C/FREZADA R/POZI MÉTRICA (U\$S/100)

ROSCA / LARGO	M3- 0,50 x	M4- 0,70 x	M5- 0,80 x	M6- 1,00 x	M8- 1,25 x	M10- 1,50 x
<b>Codigo: 203</b>						
6 mm	<sup>003</sup> 68,39	<sup>043</sup> 69,85				
8 mm	<sup>004</sup> 69,37	<sup>044</sup> 69,68	<sup>084</sup> 52,78			
10 mm	<sup>005</sup> 71,04	<sup>045</sup> 71,35	<sup>085</sup> 55,94	<sup>125</sup> 68,18		
12 mm	<sup>006</sup> 71,98	<sup>046</sup> 72,50	<sup>086</sup> 57,50	<sup>126</sup> 72,97		
16 mm	<sup>007</sup> 73,22	<sup>047</sup> 73,64	<sup>087</sup> 60,11	<sup>127</sup> 77,45	<sup>167</sup> 178,74	<sup>207</sup> 597,71
20 mm	<sup>008</sup> 75,31	<sup>048</sup> 75,68	<sup>088</sup> 63,61	<sup>128</sup> 83,32	<sup>168</sup> 193,98	<sup>208</sup> 644,73
25 mm	<sup>009</sup> 78,11	<sup>049</sup> 78,32	<sup>089</sup> 68,85	<sup>129</sup> 91,92	<sup>169</sup> 216,98	<sup>209</sup> 708,30
30 mm	<sup>010</sup> 87,97	<sup>050</sup> 88,28	<sup>090</sup> 74,47	<sup>130</sup> 100,70	<sup>170</sup> 239,74	<sup>210</sup> 772,32
35 mm		<sup>051</sup> 91,55	<sup>091</sup> 79,84	<sup>131</sup> 109,34	<sup>171</sup> 255,29	<sup>211</sup> 836,44
40 mm		<sup>052</sup> 94,36	<sup>092</sup> 88,69	<sup>132</sup> 119,82	<sup>172</sup> 289,85	<sup>212</sup> 912,26
45 mm			<sup>093</sup> 92,65	<sup>133</sup> 124,92	<sup>173</sup> 300,21	<sup>213</sup> 944,71
50 mm			<sup>094</sup> 93,83	<sup>134</sup> 128,46	<sup>174</sup> 325,31	<sup>214</sup> 1.012,37
55 mm				<sup>135</sup> 133,77	<sup>175</sup> 354,72	<sup>215</sup> 1.115,85
60 mm				<sup>136</sup> 136,41	<sup>176</sup> 361,12	<sup>216</sup> 1.180,15
65 mm				<sup>137</sup> 147,65		
70 mm				<sup>138</sup> 156,29		

LOS PRECIOS NO INCLUYEN IVA

Actualización 19/8/2024

### TORNILLO CABEZA FREZADA RANURA POZIDRIVE MÉTRICA - CANTIDAD POR CAJA

ROSCA / LARGO	M3- 0,50 x	M4- 0,70 x	M5- 0,80 x	M6- 1,00 x	M8- 1,25 x	M10- 1,50 x
<b>Codigo: 203</b>						
6 mm	<sup>003</sup> 2.400	<sup>043</sup> 2.000				
8 mm	<sup>004</sup> 2.200	<sup>044</sup> 1.900	<sup>084</sup> 1.250			
10 mm	<sup>005</sup> 2.000	<sup>045</sup> 1.800	<sup>085</sup> 1.100	<sup>125</sup> 800		
12 mm	<sup>006</sup> 2.000	<sup>046</sup> 1.600	<sup>086</sup> 1.000	<sup>126</sup> 700		
16 mm	<sup>007</sup> 1.700	<sup>047</sup> 1.500	<sup>087</sup> 800	<sup>127</sup> 600	<sup>167</sup> 350	<sup>207</sup> 350
20 mm	<sup>008</sup> 1.600	<sup>048</sup> 1.100	<sup>088</sup> 700	<sup>128</sup> 500	<sup>168</sup> 350	<sup>208</sup> 350
25 mm	<sup>009</sup> 1.300	<sup>049</sup> 850	<sup>089</sup> 550	<sup>129</sup> 450	<sup>169</sup> 300	<sup>209</sup> 300
30 mm	<sup>010</sup> 1.100	<sup>050</sup> 600	<sup>090</sup> 500	<sup>130</sup> 400	<sup>170</sup> 250	<sup>210</sup> 250
35 mm		<sup>051</sup> 550	<sup>091</sup> 400	<sup>131</sup> 350	<sup>171</sup> 200	<sup>211</sup> 200
40 mm		<sup>052</sup> 500	<sup>092</sup> 300	<sup>132</sup> 300	<sup>172</sup> 150	<sup>212</sup> 150
45 mm			<sup>093</sup> 300	<sup>133</sup> 250	<sup>173</sup> 150	<sup>213</sup> 150
50 mm			<sup>094</sup> 200	<sup>134</sup> 200	<sup>174</sup> 150	<sup>214</sup> 150
55 mm				<sup>135</sup> 200	<sup>175</sup> 150	<sup>215</sup> 150
60 mm				<sup>136</sup> 150	<sup>176</sup> 100	<sup>216</sup> 100
65 mm				<sup>137</sup> 150	<sup>177</sup> 100	<sup>217</sup> 100
70 mm				<sup>138</sup> 150	<sup>178</sup> 100	<sup>218</sup> 100

LOS PRECIOS NO INCLUYEN IVA

24/9/2024

Actualización

19/8/2024



MATERIAL:	ACERO INOXIDABLE AISI 316 - A4
TERMINACION:	PULIDO BRILLANTE
DIMENSIONES:	NORMA DIN 7985
ROSCA:	PASO MA
<b>DESCUENTOS:</b>	<b>BASE DE INOXIDABLE</b>

### PRECIOS TORNILLO CABEZA FIJADORA MÉTRICA (U\$S/100)

ROSCA / LARGO	M3- 0,50 x	M4- 0,70 x	M5- 0,80 x	M6- 1,00 x	M8- 1,25 x	M10- 1,50 x
<b>Codigo: 202</b>						
6 mm	<sup>003</sup> 68,39	<sup>043</sup> 69,85				
8 mm	<sup>004</sup> 69,37	<sup>044</sup> 69,68	<sup>084</sup> 52,78			
10 mm	<sup>005</sup> 71,04	<sup>045</sup> 71,35	<sup>085</sup> 55,94	<sup>125</sup> 68,18		
12 mm	<sup>006</sup> 71,98	<sup>046</sup> 72,50	<sup>086</sup> 57,50	<sup>126</sup> 72,97		
16 mm	<sup>007</sup> 73,22	<sup>047</sup> 73,64	<sup>087</sup> 60,11	<sup>127</sup> 77,45	<sup>167</sup> 178,74	358,63
20 mm	<sup>008</sup> 75,31	<sup>048</sup> 75,68	<sup>088</sup> 63,61	<sup>128</sup> 83,32	<sup>168</sup> 193,98	386,84
25 mm	<sup>009</sup> 78,11	<sup>049</sup> 78,32	<sup>089</sup> 68,85	<sup>129</sup> 91,92	<sup>169</sup> 216,98	424,98
30 mm	<sup>010</sup> 87,97	<sup>050</sup> 88,28	<sup>090</sup> 74,47	<sup>130</sup> 100,70	<sup>170</sup> 239,74	463,39
35 mm		<sup>051</sup> 91,55	<sup>091</sup> 79,84	<sup>131</sup> 109,34	<sup>171</sup> 255,29	501,86
40 mm		<sup>052</sup> 94,36	<sup>092</sup> 88,69	<sup>132</sup> 119,82	<sup>172</sup> 289,85	547,36
45 mm			<sup>093</sup> 92,65	<sup>133</sup> 124,92	<sup>173</sup> 300,21	566,83
50 mm			<sup>094</sup> 93,83	<sup>134</sup> 128,46	<sup>174</sup> 316,15	585,92
55 mm				<sup>135</sup> 133,77	<sup>175</sup> 325,31	607,42
60 mm				<sup>136</sup> 136,41	<sup>176</sup> 557,87	624,39
65 mm				<sup>137</sup> 147,65	<sup>177</sup> 361,12	669,51
70 mm				<sup>138</sup> 456,29	<sup>178</sup> 432,05	708,09

LOS PRECIOS NO INCLUYEN IVA

Actualización 19/8/2024

### TORNILLO CABEZA FIJADORA MÉTRICA - CANTIDAD POR CAJA

ROSCA / LARGO	M3- 0,50 x	M4- 0,70 x	M5- 0,80 x	M6- 1,00 x	M8- 1,25 x	M10- 1,50 x
<b>Codigo: 202</b>						
6 mm	<sup>003</sup> 2.400	<sup>043</sup> 2.000				
8 mm	<sup>004</sup> 2.200	<sup>044</sup> 1.900	<sup>084</sup> 1.250			
10 mm	<sup>005</sup> 2.000	<sup>045</sup> 1.800	<sup>085</sup> 1.100	<sup>125</sup> 800		
12 mm	<sup>006</sup> 2.000	<sup>046</sup> 1.600	<sup>086</sup> 1.000	<sup>126</sup> 700		
16 mm	<sup>007</sup> 1.700	<sup>047</sup> 1.500	<sup>087</sup> 800	<sup>127</sup> 600	<sup>167</sup> 350	
20 mm	<sup>008</sup> 1.600	<sup>048</sup> 1.100	<sup>088</sup> 700	<sup>128</sup> 500	<sup>168</sup> 350	
25 mm	<sup>009</sup> 1.300	<sup>049</sup> 850	<sup>089</sup> 550	<sup>129</sup> 450	<sup>169</sup> 300	
30 mm	<sup>010</sup> 1.100	<sup>050</sup> 600	<sup>090</sup> 500	<sup>130</sup> 400	<sup>170</sup> 250	
35 mm		<sup>051</sup> 550	<sup>091</sup> 400	<sup>131</sup> 350	<sup>171</sup> 200	
40 mm		<sup>052</sup> 500	<sup>092</sup> 300	<sup>132</sup> 300	<sup>172</sup> 150	
45 mm			<sup>093</sup> 300	<sup>133</sup> 250	<sup>173</sup> 150	
50 mm			<sup>094</sup> 200	<sup>134</sup> 200	<sup>174</sup> 150	
55 mm				<sup>135</sup> 200	<sup>175</sup> 150	
60 mm				<sup>136</sup> 150	<sup>176</sup> 100	
65 mm				<sup>137</sup> 150	<sup>177</sup> 100	
70 mm				<sup>138</sup> 150	<sup>178</sup> 100	

LOS PRECIOS NO INCLUYEN IVA

24/9/2024

Actualización 19/8/2024



MATERIAL	ACERO INOXIDABLE AISI 316 - A4
TERMINACION	PULIDO BRILLANTE
DIMENSIONES:	DIN 7981 (EN ISO 7049)
ROSCA:	TIPO AB
DESCUENTOS:	BASE DE INOXIDABLE

**PRECIOS TORNILLO PARKER C/FIJADORA R/COMBINADA (U\$S/100)**

ROSCA / LARGO	4 x	6 x	7 x	8 x	10 x	12 x	14 x
<b>Codigo: 210</b>	<b>2,80 mm</b>	<b>3,00 mm</b>	<b>3,90 mm</b>	<b>4,20 mm</b>	<b>4,80 mm</b>	<b>5,50 mm</b>	<b>6,40 mm</b>
1/4	27,76						
5/16	28,63	35,05					
3/8	29,50	35,05	55,87	43,13	52,33		
1/2	30,99	37,58	55,87	46,67	52,33	72,97	108,26
5/8	32,55	40,08	56,04	50,14	63,67	74,95	116,26
3/4	34,18	42,61	56,91	53,61	65,24	88,94	124,23
7/8	35,74	45,11	57,78	57,08	66,90	89,80	132,14
1"	37,41	47,64	59,79	60,66	67,84	98,37	140,12
1 1/4		55,28	63,67	63,67	69,23	103,68	155,91
1 1/2		56,04	66,80	66,80	87,03	109,83	164,93
1 3/4				74,95	96,47	119,13	189,98
2"				80,16	102,37	124,92	203,69
2 1/4					104,55	131,79	225,55
2 1/2					117,04	135,68	235,44
2 3/4							251,58

PARA: Tarugo 5 mm Tarugo 6 mm Tarugo 6 mm Tarugo 8 mm Tarugo 8 mm

LOS PRECIOS NO INCLUYEN IVA

Actualización 19/8/2024

**TORNILLOS PARKER CABEZA FIJADORA RANURA  
COMBINADA - CANTIDAD POR CAJA**

ROSCA / LARGO	4 x	6 x	7 x	8 x	10 x	12 x	14 x
<b>Codigo: 210</b>	<b>2,80 mm</b>	<b>3,00 mm</b>	<b>3,90 mm</b>	<b>4,20 mm</b>	<b>4,80 mm</b>	<b>5,50 mm</b>	<b>6,40 mm</b>
1/4	2.400						
5/16	2.300	1.700					
3/8	2.200	1.600	1.600	1.800	1.200		
1/2	2.100	1.500	1.500	1.600	1.100	900	600
5/8	2.000	1.400	1.400	1.300	1.000	800	500
3/4	1.800	1.200	1.200	1.100	900	700	450
7/8	1.600	1.000	1.000	1.000	800	600	400
1"	1.400	800	800	900	600	500	350
1 1/4		700	700	600	500	400	300
1 1/2		600	600	500	400	300	250
1 3/4				400	300	250	200
2"				300	250	200	150
2 1/4					200	200	150
2 1/2					150	150	150
2 3/4							150

24/9/2024

LOS PRECIOS NO INCLUYEN IVA

Actualización 19/8/2024

# TUBULON S.A.

MOLINA ARROTEA 1150 LOMAS DE ZAMORA (1832) BS. AS.  
 TEL: (+54 11) 4243 5823 / 4392 4278 / 4292 0965  
 E-MAIL : VENTAS@TUBULON.COM.AR  
 WEB: WWW.TUBULON.COM.AR



MATERIAL	ACERO INOXIDABLE AISI 316 - A4
TERMINACION	PULIDO BRILLANTE
DIMENSIONES:	NORMA DIN 7982 (EN ISO 7050)
ROSCA:	TIPO AB
DESCUENTOS:	BASE DE INOXIDABLE

## PRECIOS TORNILLOS PARKER C/FREZADA R/POZIDRIVE (U\$/100)

ROSCA / LARGO	4 x	6 x	7 x	8 x	10 x	12 x	14 x
Codigo: 211	2,80 mm	3,00 mm	3,90 mm	4,20 mm	4,80 mm	5,50 mm	6,40 mm
1/4	27,76 <sup>000</sup>						
5/16	28,63 <sup>001</sup>	35,05 <sup>041</sup>					
3/8	29,50 <sup>002</sup>	35,05 <sup>042</sup>	55,87 <sup>082</sup>	43,13 <sup>122</sup>	52,33 <sup>162</sup>		
1/2	30,99 <sup>003</sup>	37,58 <sup>043</sup>	55,87 <sup>083</sup>	46,67 <sup>123</sup>	52,33 <sup>163</sup>	72,97 <sup>203</sup>	108,26 <sup>243</sup>
5/8	32,55 <sup>004</sup>	40,08 <sup>044</sup>	56,04 <sup>084</sup>	50,14 <sup>124</sup>	63,67 <sup>164</sup>	74,95 <sup>204</sup>	116,26 <sup>244</sup>
3/4	34,18 <sup>005</sup>	42,61 <sup>045</sup>	56,91 <sup>085</sup>	53,61 <sup>125</sup>	65,24 <sup>165</sup>	88,94 <sup>205</sup>	124,23 <sup>245</sup>
7/8	35,74 <sup>006</sup>	45,11 <sup>046</sup>	57,78 <sup>086</sup>	57,08 <sup>126</sup>	66,90 <sup>166</sup>	89,80 <sup>206</sup>	132,14 <sup>246</sup>
1"	37,41 <sup>007</sup>	47,64 <sup>047</sup>	59,79 <sup>087</sup>	60,66 <sup>127</sup>	67,84 <sup>167</sup>	98,37 <sup>207</sup>	140,12 <sup>247</sup>
1 1/4		55,28 <sup>048</sup>	63,67 <sup>088</sup>	63,67 <sup>128</sup>	69,23 <sup>168</sup>	103,68 <sup>208</sup>	155,91 <sup>248</sup>
1 1/2		56,04 <sup>049</sup>	66,80 <sup>089</sup>	66,80 <sup>129</sup>	87,03 <sup>169</sup>	109,83 <sup>209</sup>	164,93 <sup>249</sup>
1 3/4				74,95 <sup>130</sup>	96,47 <sup>170</sup>	119,13 <sup>210</sup>	189,98 <sup>250</sup>
2"				80,16 <sup>131</sup>	102,37 <sup>171</sup>	124,92 <sup>211</sup>	203,69 <sup>251</sup>
2 1/4					104,55 <sup>172</sup>	131,79 <sup>212</sup>	225,55 <sup>252</sup>
2 1/2					117,04 <sup>173</sup>	135,68 <sup>213</sup>	235,44 <sup>253</sup>
2 3/4							251,58 <sup>254</sup>

PARA: Tarugo 5 mm Tarugo 6 mm Tarugo 6 mm Tarugo 8 mm Tarugo 8 mm

LOS PRECIOS NO INCLUYEN IVA

Actualización 19/8/2024

# TUBULON S.A.

## TORNILLOS PARKER CABEZA FREZADA RANURA POZIDRIVE - CANTIDAD POR CAJA

ROSCA / LARGO	4 x	6 x	7 x	8 x	10 x	12 x	14 x
Codigo: 211	2,80 mm	3,00 mm	3,90 mm	4,20 mm	4,80 mm	5,50 mm	6,40 mm
1/4	2.400 <sup>000</sup>						
5/16	2.300 <sup>001</sup>	1.700 <sup>041</sup>					
3/8	2.200 <sup>002</sup>	1.600 <sup>042</sup>	1.600 <sup>082</sup>	1.800 <sup>122</sup>	1.200 <sup>162</sup>		
1/2	2.100 <sup>003</sup>	1.500 <sup>043</sup>	1.500 <sup>083</sup>	1.600 <sup>123</sup>	1.100 <sup>163</sup>	900 <sup>203</sup>	600 <sup>243</sup>
5/8	2.000 <sup>004</sup>	1.400 <sup>044</sup>	1.400 <sup>084</sup>	1.300 <sup>124</sup>	1.000 <sup>164</sup>	800 <sup>204</sup>	500 <sup>244</sup>
3/4	1.800 <sup>005</sup>	1.200 <sup>045</sup>	1.200 <sup>085</sup>	1.100 <sup>125</sup>	900 <sup>165</sup>	700 <sup>205</sup>	450 <sup>245</sup>
7/8	1.600 <sup>006</sup>	1.000 <sup>046</sup>	1.000 <sup>086</sup>	1.000 <sup>126</sup>	800 <sup>166</sup>	600 <sup>206</sup>	400 <sup>246</sup>
1"	1.400 <sup>007</sup>	800 <sup>047</sup>	800 <sup>087</sup>	900 <sup>127</sup>	600 <sup>167</sup>	500 <sup>207</sup>	350 <sup>247</sup>
1 1/4		700 <sup>048</sup>	700 <sup>088</sup>	600 <sup>128</sup>	500 <sup>168</sup>	400 <sup>208</sup>	300 <sup>248</sup>
1 1/2		600 <sup>049</sup>	600 <sup>089</sup>	500 <sup>129</sup>	400 <sup>169</sup>	300 <sup>209</sup>	250 <sup>249</sup>
1 3/4				400 <sup>130</sup>	300 <sup>170</sup>	250 <sup>210</sup>	200 <sup>250</sup>
2"				300 <sup>131</sup>	250 <sup>171</sup>	200 <sup>211</sup>	150 <sup>251</sup>
2 1/4					200 <sup>172</sup>	200 <sup>212</sup>	150 <sup>252</sup>
2 1/2					150 <sup>173</sup>	150 <sup>213</sup>	150 <sup>253</sup>
2 3/4							150 <sup>254</sup>

LOS PRECIOS NO INCLUYEN IVA

24/9/2024

Actualización 19/8/2024



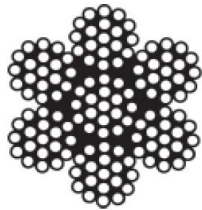

MATERIAL:	ACERO INOXIDABLE AISI 316 - A4
TERMINACION:	PULIDO BRILLANTE
DIMENSIONES CABLE:	NORMA DIN 3060
DESCUENTOS:	BASE DE INOXIDABLE



## PRECIOS DE CABLE (7 x 19)

Codigo: 230	DIAMETRO (mm)	Metros x Carrete	CONSTRUCCION (cordon/hilos)	DIAM. ALAMBRE (mm)	DIAM. POLEA (mm)	CARGA DE ROTURA (Efect. kgs)	PRECIO (U\$S/100)
001	2.00	1000	7 x 19	0,13	70	210,00	257,04
002	2.50	1000	7 x 19	0,16	88	300,00	483,84
003	3.00	1000	7 x 19	0,20	105	450,00	571,20
004	3.50	1000	7 x 19	0,38	125	630,00	619,92
005	4.00	1000	7 x 19	0,27	140	850,00	668,64
006	5.00	1000	7 x 19	0,33	175	1.320,00	850,08
007	6.00	1000	7 x 19	0,40	210	1.800,00	1.125,60
008	6.35	1000	7 x 19	0,42	223	2.050,00	1.149,12
009	7.00	1000	7 x 19			2.800,00	1.533,84
010	8.00	1000	7 x 19	0,53	280	3.200,00	2.219,28
011	9.52	1000	7 x 19	0,63	334	4.600,00	3.321,36
012	10.00	1000	7 x 19			4.800,00	3.528,00
013	12.70	1000	7 x 19	0,85	445	8.200,00	4.940,88

LOS PRECIOS NO INCLUYEN IVA

## PRECIO DE CADENA

Codigo: 220	DIÁMETRO	(en mm)	b2 (mm)	L (mm)	P (mm)	CARGA ROTURA (Kgs)	CARGA SEGURO (Kgs)	PRECIO (U\$S/Mtro)
001	M3	3,00	11,00	24,00	18,00	165,00	55,00	15,84
002	M4	4,00	15,00	27,00	19,00	300,00	100,00	27,17
003	M5	5,00	18,00	33,00	23,00	480,00	160,00	36,84
004	M6	6,00	22,00	40,00	28,00	672,00	224,00	50,95
005	M8	8,00	31,00	49,00	33,00	1.200,00	400,00	84,89
006	M10	10,00	37,00	56,00	36,00	1.890,00	630,00	139,40

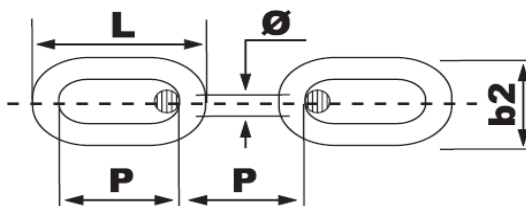

LOS PRECIOS NO INCLUYEN IVA

Actualización

19/8/2024

<b>MATERIAL:</b>	<b>ACERO INOXIDABLE AISI 316 - A4</b>
<b>TERMINACION:</b>	<b>PULIDO BRILLANTE</b>
<b>DESCUENTOS:</b>	<b>BASE DE INOXIDABLE</b>

## PRECIOS DE UNION DE CADENA

Codigo: 221	CANTIDAD POR CAJA	D mm	L mm	L1 mm	B mm	B1 mm	CARGA SEGURA (Kgs)	CARGA ROTURA (Kgs)	PRECIO (U\$/1000)
001	100	M4	41	6	6	11	200,00	653,00	475,44
002	100	M5	49	8	8	13	300,00	1265,00	623,28
003	50	M6	58	9	9	15	400,00	1734,00	757,68
004	20	M8	74	10	10	18	795,00	3661,00	1.515,36
005	30	M10	90	11	11	21	1193,00	3875,00	2.525,04
006	15	M12	110	15	15	26	1497,00	4365,00	3.578,40

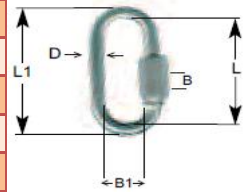

## PRECIOS DE DESTORCEDOR HORQUILLA/HORQUILLA

Codigo: 222	CANTIDAD POR CAJA	D mm	L mm	B mm	C mm	CARGA SEGURA (Kgs)	CARGA ROTURA (Kgs)	PRECIO (U\$/1000)
001	40	M5	60	10	11	163,15	479,26	1.172,64
002	30	M6	66	12	11	295,71	866,75	1.500,24
003	8	M8	94	16	16	479,26	1427,58	2.553,60
004	8	M10	118	20	22	632,21	1835,46	4.648,56
005	4	M12	152	26	28	876,94	2549,25	10.471,44

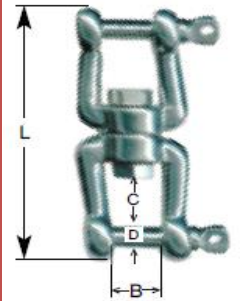

## PRECIOS DE DESTORCEDOR OJO/HORQUILLA

Codigo: 223	CANTIDAD POR CAJA	D mm	L mm	B mm	C mm	B1 mm	CARGA SEGURA (Kgs)	CARGA ROTURA (Kgs)	PRECIO (U\$/1000)
001	50	M5	60	10	11	13	163,15	479,26	1.172,64
002	40	M6	66	12	11	15	295,71	866,75	1.500,24
003	30	M8	94	16	16	20	479,26	1427,58	2.553,60
004	10	M10	118	20	22	24	632,21	1835,46	4.648,56
005	5	M12	152	26	28	32	876,94	2549,25	10.471,44

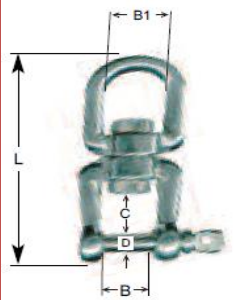

## PRECIOS DE DESTORCEDOR OJO/OJO

Codigo: 224	CANTIDAD POR CAJA	D mm	L mm	L1 mm	B mm	B1 mm	CARGA SEGURA (Kgs)	CARGA ROTURA (Kgs)	PRECIO (U\$/1000)
001	50	M5	60	13	23	13	203,94	611,82	1.068,48
002	50	M6	65	15	26	15	346,70	1019,70	1.276,80
003	25	M8	90	22	35	20	601,62	1835,46	2.375,52
004	12	M10	115	27	44	24	795,37	2345,31	4.262,16
005	5	M12	154	35	57	32	999,31	2957,13	10.024,56

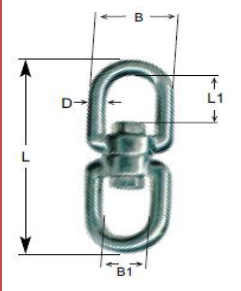

LOS PRECIOS NO INCLUYEN IVA

Actualización 19/8/2024

MOLINA ARROTEA 1150 LOMAS DE ZAMORA (1832) BS. AS.

TEL: (+54 11) 4243 5823 / 4392 4278 / 4292 0965

E-MAIL : VENTAS@TUBULON.COM.AR

WEB: WWW.TUBULON.COM.AR

MATERIAL:	ACERO INOXIDABLE AISI 316 - A4
TERMINACION:	PULIDO BRILLANTE
DESCUENTOS:	BASE DE INOXIDABLE

## PRECIOS DE PRENSACABLES

Codigo: 231	CANTIDAD POR CAJA	MEDIDA	PRECIO (U\$S/100)
001	200	M3	573,89
002	200	M4	600,23
003	150	M5	622,81
004	100	M5	814,73
005	65	M8	863,65
006	35	M10	1.437,54
007	20	M12	2.013,31



## PRECIOS DE TENSORES OJO/GANCHO

Codigo: 232	CANTIDAD POR CAJA	MEDIDA	CARGA SEGURA (Kgs)	CARGA ROTURA (Kgs)	PRECIO (U\$S/100)
001		M3			
002		M4			
003	50	M5	60,00	180,00	2.254,90
004	40	M6	70,00	230,00	2.613,17
005	12	M8	140,00	400,00	4.032,65
006	10	M10	220,00	600,00	5.843,50
007	10	M12	310,00	800,00	8.060,78



## PRECIOS DE GRILLETES OMEGA

Codigo: 233	CANTIDAD POR CAJA	MEDIDA	CARGA SEGURA (Kgs)	CARGA ROTURA (Kgs)	PRECIO (U\$S/100)
001	100	M5	80,00	240,00	965,26
002	75	M6	100,00	300,00	991,61
003	35	M8	200,00	600,00	1.125,73
004	15	M10	320,00	960,00	1.531,62
005	10	M12	520,00	1560,00	2.643,65



## PRECIOS DE GRILLETES RECTO

Codigo: 234	CANTIDAD POR CAJA	MEDIDA	CARGA SEGURA (Kgs)	CARGA ROTURA (Kgs)	PRECIO (U\$S/100)
001	100	M5	80,00	240,00	858,01
002	75	M6	100,00	300,00	880,59
003	35	M8	200,00	600,00	1.001,01
004	15	M10	320,00	960,00	1.362,28
005	10	M12	520,00	1560,00	2.350,12



LOS PRECIOS NO INCLUYEN IVA

Actualización 19/8/2024

MATERIAL	ACERO INOXIDABLE AISI 316 - A4
TERMINACION	PULIDO BRILLANTE
<b>DESCUENTOS:</b>	<b>BASE DE INOXIDABLE</b>

## PRECIOS DE CANCAMOS MACHO DIN 580

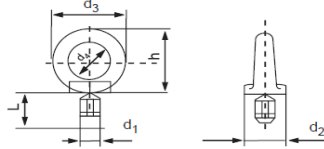

Codigo:	CANTIDAD POR CAJA	MEDIDA	d2 (mm)	d3 (mm)	d4 (mm)	h	L	CARGA SEGURA (Kgs)	PRECIO (U\$S/100)
<b>237</b>									
001	40	M8- 1,25	20,0	36,0	20,0	36,0	13,0	140	979,69
002	20	M10- 1,50	25,0	45,0	25,0	45,0	17,0	230	1.530,70
003	10	M12- 1,75	30,0	54,0	30,0	53,0	20,5	340	2.512,57

## PRECIOS DE CANCAMOS HEMBRA DIN 582

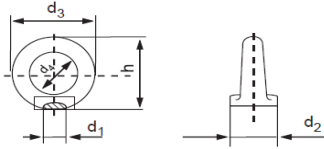

Codigo:	CANTIDAD POR CAJA	MEDIDA	d2 (mm)	d3 (mm)	d4 (mm)	h	L	CARGA SEGURA (Kgs)	PRECIO (U\$S/100)
<b>238</b>									
001	40	M8- 1,25	20	36,0	20,0	36,0	13,0	140	932,01
002	20	M10- 1,50	25	45,0	25,0	45,0	17,0	230	1.491,63
003	10	M12- 1,75	30	54,0	30,0	53,0	20,5	340	2.341,71



## PRECIOS DE GUARDACABOS

Codigo:	CANTIDAD POR CAJA	MEDIDA	PRECIO (U\$S/100)
<b>235</b>			
001	400	M3	152,41
002	300	M4	176,87
003	150	M5	291,65
004	80	M6	325,51
005	35	M8	455,35
006	20	M10	715,01
007	15	M12	929,51

## PRECIOS DE MOSQUETONES

Codigo:	CANTIDAD POR CAJA	MEDIDA	PRECIO (U\$S/100)
<b>236</b>			
001	100	M4	755,55
002	100	M5	880,59
003	60	M6	1.013,77
004	25	M8	1.713,76
005	15	M10	2.182,84
006	12	M12	3.664,60

## PRECIOS DE CORNAMUZA

Codigo:	CANTIDAD POR CAJA	MEDIDA	A	B	C	PESO	PRECIO (U\$S/100)
<b>369</b>							
002	100	4"	100	25	30	0,07	4.674,09
003	100	5"	126	27	38	0,10	5.126,26
004	60	6"	152	34	45	0,16	7.237,08
005	25	8"	200	40	55	0,28	10.554,07
006	15	10"	250	45	60	0,45	18.092,69
007	12	12"	300	56	74	0,71	25.631,00

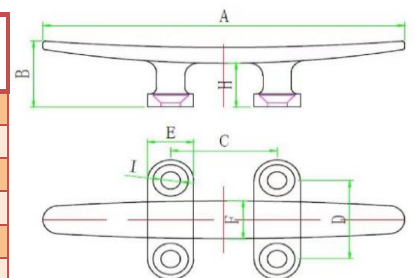

LOS PRECIOS NO INCLUYEN IVA

Actualización 19/8/2024

Administración, fábrica y ventas:

MOLINA ARROTEA 1150 LOMAS DE ZAMORA (1832) BS. AS.

TEL: (+54 11) 4243 5823 / 4392 4278 / 4292 0965

E-MAIL : VENTAS@TUBULON.COM.AR

WEB: WWW.TUBULON.COM.AR

<b>MATERIAL:</b>	<b>PTFE</b>
<b>TERMINACION:</b>	<b>BLANCO</b>
<b>PRESION:</b>	<b>150LBS</b>
<b>DESCUENTOS:</b>	<b>BASE INOXIDABLE</b>

## KIT DE ACCESORIOS VALVULAS- PIEZAS 6,7,9,10

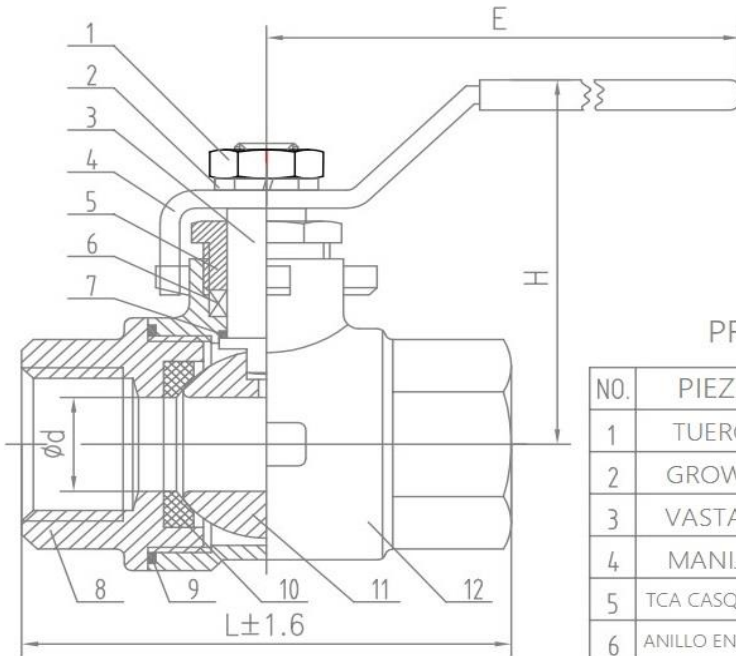

### PRINCIPALES PIEZAS Y MATERIALES

NO.	PIEZA	MATERIAL	NO.	PIEZA	MATERIAL
1	TUERCA	304/316	7	ARANDELA EMPUJE	PTFE
2	GROWER	304/316	8	TAPA	WCB/CF8/CF8M
3	VASTAGO	304/316	9	JUNTA	PTFE
4	MANIJA	201	10	ASIENTO	PTRE/RPTFE
5	TCA CASQUILLO	304/316	11	BOLA	304/316
6	ANILLO ENSAMBLE	PTFE	12	CUERPO	WCB/CF8/CF8M

<b>Codigo:</b> <b>72-420</b>		<b>PARA VALVULAS DE 2 CUERPOS</b>
<b>Codigo:</b> <b>72-421</b>		<b>PARA VALVULAS DE 3 CUERPOS</b>
<b>Codigo:</b> <b>72-422</b>		<b>PARA VALVULAS DE 3 VIAS</b>
<b>Codigo:</b> <b>72-423</b>		<b>PARA VALVULA MARIPOSA</b>

Administración, fábrica y ventas:

MOLINA ARROTEA 1150 LOMAS DE ZAMORA (1832) BS. AS.

TEL: (+54 11) 4243 5823 / 4392 4278 / 4292 0965

E-MAIL : VENTAS@TUBULON.COM.AR

WEB: WWW.TUBULON.COM.AR

<b>MATERIAL:</b>	<b>ACERO INOXIDABLE AISI316</b>
<b>MEDIDAS:</b>	<b>PN25</b>
<b>TIPO DE ROSCA:</b>	<b>BSP (Rosca Gas)</b>
<b>TERMINACION:</b>	<b>PULIDO</b>
<b>PRESION:</b>	<b>1000 WOG - #150 Lbs</b>
<b>ANILLO INTERNO:</b>	<b>PTFE</b>
<b>DESCUENTOS:</b>	<b>BASE INOXIDABLE</b>

## VALVULA ESFERICA 2 CUERPOS ROSCADA

<b>Codigo:</b> <b>71-250</b>	<b>MEDIDA</b>	<b>PRECIO</b> <b>(U\$S/UNI.)</b>	<b>KIT</b> <b>ACCESORIO</b> <b>(U\$S/Uni.)</b>
<b>004</b>	<b>1/4- 19</b>	<b>20,36</b>	<b>0,91</b>
<b>006</b>	<b>3/8- 19</b>	<b>20,36</b>	<b>0,91</b>
<b>008</b>	<b>1/2- 14</b>	<b>20,94</b>	<b>0,90</b>
<b>011</b>	<b>3/4- 14</b>	<b>28,38</b>	<b>1,21</b>
<b>013</b>	<b>1"- 11</b>	<b>41,96</b>	<b>1,79</b>
<b>015</b>	<b>1 1/4- 11</b>	<b>58,09</b>	<b>3,15</b>
<b>017</b>	<b>1 1/2- 11</b>	<b>73,63</b>	<b>3,36</b>
<b>021</b>	<b>2"- 11</b>	<b>102,60</b>	<b>4,38</b>
<b>023</b>	<b>2 1/2- 11</b>	<b>210,79</b>	<b>8,70</b>
<b>025</b>	<b>3"- 11</b>	<b>322,92</b>	<b>13,07</b>
<b>029</b>	<b>4"- 11</b>	<b>533,08</b>	<b>21,23</b>



## VALVULA MARIPOSA c/4 POSICIONES p/SOLDAR

<b>Codigo:</b> <b>73-270</b>	<b>MEDIDA</b>	<b>PRECIO</b> <b>(U\$S/UNI.)</b>	<b>KIT</b> <b>ACCESORIO</b> <b>(U\$S/Uni.)</b>
<b>011</b>	<b>3/4</b>	<b>102,71</b>	<b>4,66</b>
<b>013</b>	<b>1"</b>	<b>101,00</b>	<b>4,56</b>
<b>015</b>	<b>1 1/4</b>	<b>98,92</b>	<b>4,46</b>
<b>017</b>	<b>1 1/2</b>	<b>94,33</b>	<b>3,66</b>
<b>021</b>	<b>2"</b>	<b>130,34</b>	<b>5,01</b>
<b>023</b>	<b>2 1/2</b>	<b>196,37</b>	<b>7,56</b>
<b>025</b>	<b>3"</b>	<b>224,02</b>	<b>8,67</b>



Administración, fábrica y ventas:

MOLINA ARROTEA 1150 LOMAS DE ZAMORA (1832) BS. AS.

TEL: (+54 11) 4243 5823 / 4392 4278 / 4292 0965

E-MAIL : VENTAS@TUBULON.COM.AR

WEB: WWW.TUBULON.COM.AR

<b>MATERIAL:</b>	<b>ACERO INOXIDABLE AISI316</b>
<b>MEDIDAS:</b>	<b>PN25</b>
<b>TIPO DE ROSCA:</b>	<b>BSP (Rosca Inglesa Gas)</b>
<b>TERMINACION:</b>	<b>PULIDO</b>
<b>PRESION:</b>	<b>1000 WOG - #150 Lbs</b>
<b>ANILLO INTERNO:</b>	<b>PTFE</b>
<b>DESCUENTOS:</b>	<b>BASE INOXIDABLE</b>

## VALVULA ESFERICA 3 CPOS- ACCIONAMIENTO MANUAL

<b>Codigo:</b> <b>71-255</b>	<b>MEDIDA</b>	<b>PRECIO (U\$S/UNI.)</b>	<b>KIT ACCESORIO (U\$S/Uni.)</b>
<b>008</b>	<b>1/2- 14</b>	<b>30,50</b>	<b>2,13</b>
<b>011</b>	<b>3/4- 14</b>	<b>42,94</b>	<b>2,91</b>
<b>013</b>	<b>1"- 11</b>	<b>51,90</b>	<b>3,74</b>
<b>015</b>	<b>1 1/4- 11</b>	<b>89,50</b>	<b>5,57</b>
<b>017</b>	<b>1 1/2- 11</b>	<b>110,33</b>	<b>6,90</b>
<b>021</b>	<b>2"- 11</b>	<b>160,70</b>	<b>9,87</b>
<b>023</b>	<b>2 1/2- 11</b>	<b>265,89</b>	<b>18,16</b>
<b>025</b>	<b>3"- 11</b>	<b>506,65</b>	<b>25,98</b>
<b>029</b>	<b>4"- 11</b>	<b>905,48</b>	<b>48,85</b>



## VALVULA ESFERICA 3 CPOS- MANUAL Y ACTUADOR

<b>Codigo:</b> <b>71-451</b>	<b>MEDIDA</b>	<b>PRECIO (U\$S/UNI.)</b>	<b>KIT ACCESORIO (U\$S/Uni.)</b>
<b>008</b>	<b>1/2- 14</b>	<b>44,20</b>	<b>2,13</b>
<b>011</b>	<b>3/4- 14</b>	<b>59,46</b>	<b>2,91</b>
<b>013</b>	<b>1"- 11</b>	<b>77,43</b>	<b>3,74</b>
<b>015</b>	<b>1 1/4- 11</b>	<b>115,62</b>	<b>5,57</b>
<b>017</b>	<b>1 1/2- 11</b>	<b>144,56</b>	<b>6,90</b>
<b>021</b>	<b>2"- 11</b>	<b>206,28</b>	<b>9,87</b>
<b>023</b>	<b>2 1/2- 11</b>	<b>450,40</b>	<b>18,16</b>
<b>025</b>	<b>3"- 11</b>	<b>644,78</b>	<b>25,98</b>
<b>029</b>	<b>4"- 11</b>	<b>997,49</b>	<b>48,85</b>



LOS PRECIOS NO INCLUYEN IVA

Administración, fábrica y ventas:

MOLINA ARROTEA 1150 LOMAS DE ZAMORA (1832) BS. AS.

TEL: (+54 11) 4243 5823 / 4392 4278 / 4292 0965

E-MAIL : VENTAS@TUBULON.COM.AR

WEB: WWW.TUBULON.COM.AR

MATERIAL:	ACERO INOXIDABLE AISI316
MEDIDAS:	PN25
TIPO DE ROSCA:	NPT (Conica Americana)
TERMINACION:	PULIDO
PRESION:	1000 WOG - #150 Lbs
ANILLO INTERNO:	PTFE
<b>DESCUENTOS:</b>	<b>BASE INOXIDABLE</b>

## VALVULA ESFERICA 3 CPOS- ACCIONAMIENTO MANUAL

Codigo: 71-257	MEDIDA	PRECIO (U\$S/UNI.)	KIT ACCESORIO (U\$S/Uni.)
008	1/2- 14	35,40	2,13
011	3/4- 14	45,47	2,91
013	1"- 11,5	55,89	3,74
015	1 1/4- 11,5	89,74	5,57
017	1 1/2- 11,5	123,82	6,90
021	2"- 11,5	171,41	9,87
023	2 1/2- 8	353,30	18,16
025	3"- 8	506,65	25,98
029	4"- 8	905,48	48,85



## VALVULA ESFERICA 3 CPOS- MANUAL Y ACTUADOR

Codigo: 71-258	MEDIDA	PRECIO (U\$S/UNI.)	KIT ACCESORIO (U\$S/Uni.)
008	1/2- 14	47,53	2,13
011	3/4- 14	60,65	2,91
013	1"- 11,5	79,61	3,74
015	1 1/4- 11,5	119,22	5,57
017	1 1/2- 11,5	151,10	6,90
021	2"- 11,5	217,52	9,87
023	2 1/2- 8	402,34	18,16
025	3"- 8	558,44	25,98
029	4"- 8	1.099,51	48,85





Administración, fábrica y ventas:

MOLINA ARROTEA 1150 LOMAS DE ZAMORA (1832) BS. AS.

TEL: (+54 11) 4243 5823 / 4392 4278 / 4292 0965

E-MAIL : VENTAS@TUBULON.COM.AR

WEB: WWW.TUBULON.COM.AR

MATERIAL:	ACERO INOXIDABLE AISI316
MEDIDAS:	PN25
TIPO DE ROSCA:	SOCKET WELD (Para Soldar)
TERMINACION:	PULIDO
PRESION:	1000 WOG - #150 Lbs
ANILLO INTERNO:	PTFE
<b>DESCUENTOS:</b>	<b>BASE INOXIDABLE</b>

## VALVULA ESFERICA 3 CPOS- ACCIONAMIENTO MANUAL

Codigo: 71-259	MEDIDA	PRECIO (U\$S/UNI.)	KIT ACCESORIO (U\$S/Uni.)
008	1/2- 14	38,38	2,13
011	3/4- 14	43,88	2,91
013	1"- 11	63,06	3,74
015	1 1/4- 11	91,71	5,57
017	1 1/2- 11	128,54	6,90
021	2"- 11	166,92	9,87
023	2 1/2- 11	331,55	18,16
025	3"- 11	526,46	25,98
029	4"- 11	1.025,44	48,85



## VALVULA ESFERICA 3 CPOS- MANUAL Y ACTUADOR

Codigo: 71- 260	MEDIDA	PRECIO (U\$S/UNI.)	KIT ACCESORIO (U\$S/Uni.)
008	1/2- 14	51,19	2,13
011	3/4- 14	56,80	2,91
013	1"- 11	86,71	3,74
015	1 1/4- 11	109,98	5,57
017	1 1/2- 11	154,69	6,90
021	2"- 11	198,83	9,87
023	2 1/2- 11	372,20	18,16
025	3"- 11	521,60	25,98
029	4"- 11	1.065,73	48,85



LOS PRECIOS NO INCLUYEN IVA

Administración, fábrica y ventas:

MOLINA ARROTEA 1150 LOMAS DE ZAMORA (1832) BS. AS.

TEL: (+54 11) 4243 5823 / 4392 4278 / 4292 0965

E-MAIL : VENTAS@TUBULON.COM.AR

WEB: WWW.TUBULON.COM.AR

MATERIAL:	ACERO INOXIDABLE AISI316
MEDIDAS:	PN25
TIPO DE ROSCA:	BSP (Rosca Inglesa Gas)
TERMINACION:	PULIDO
PRESION:	1000 WOG - #150 Lbs
ANILLO INTERNO:	PTFE
<b>DESCUENTOS:</b>	<b>BASE INOXIDABLE</b>

## VALVULA ESFERICA 3 VIAS EN L - MANUAL Y ACTUADOR

Codigo: 71-235	MEDIDA	PRECIO (U\$S/UNI.)	KIT ACCESORIO (U\$S/Uni.)
008	1/2- 14	64,42	2,80
011	3/4- 14	85,79	3,74
013	1"- 11	132,72	5,74
015	1 1/4- 11	220,22	9,51
017	1 1/2- 11	319,89	13,83
021	2"- 11	490,37	21,22
023	2 1/2- 11	768,87	33,29



## VALVULA ESFERICA 3 VIAS EN I - MANUAL ACTUADOR

Codigo: 71-238	MEDIDA	PRECIO (U\$S/UNI.)	KIT ACCESORIO (U\$S/Uni.)
008	1/2- 14	64,42	2,80
011	3/4- 14	85,79	3,74
013	1"- 11	132,72	5,74
015	1 1/4- 11	220,22	9,51
017	1 1/2- 11	319,89	13,83
021	2"- 11	490,37	21,22
023	2 1/2- 11	768,87	33,29



# TUBULON S.A.

MOLINA ARROTEA 1150 LOMAS DE ZAMORA (1832) BS. AS.

TEL: (+54 11) 4243 5823 / 4392 4278 / 4292 0965

E-MAIL : VENTAS@TUBULON.COM.AR

WEB: WWW.TUBULON.COM.AR

MATERIAL:	ACERO INOXIDABLE AISI 316 - A4
MEDIDAS:	ISO4144
TIPO DE	BSP - BSPT
TERMINACIO	PULIDO BRILLANTE
PRESION:	150Lbs
<b>DESCUENTO</b>	<b>BASE DE INOXIDABLE</b>



**CODO 90° H-H**



**CODO 90° H-M**

Codigo:	MEDIDA	PRECIO (U\$/un)
275		
004	1/4	3,39
006	3/8	3,75
008	1/2	4,41
011	3/4	6,62
013	1"	10,18
015	1 1/4	16,66
017	1 1/2	21,21
021	2"	30,17
023	2 1/2	62,36
025	3"	90,36
029	4"	145,09

DIAMETRO NOMINAL
13,72
17,15
21,34
26,67
33,40
42,16
48,26
60,33
73,03
88,90
114,30

Codigo:	MEDIDA	PRECIO (U\$/un)
276		
004	1/4	3,60
006	3/8	4,62
008	1/2	5,77
011	3/4	7,61
013	1"	11,88
015	1 1/4	19,61
017	1 1/2	25,27
021	2"	39,28
023	2 1/2	78,32
025	3"	100,31
029	4"	156,73



**CODO 45° H-H**



**TEE HEMBRA**



**CRUZ HEMBRA**

Codigo:	MEDIDA	PRECIO (U\$/un)
277		
004	1/4	4,04
006	3/8	4,45
008	1/2	5,20
011	3/4	7,47
013	1"	10,84
015	1 1/4	15,58
017	1 1/2	19,97
021	2"	32,51
023	2 1/2	53,03

Codigo:	MEDIDA	PRECIO (U\$/un)
278		
004	1/4	4,41
006	3/8	5,94
008	1/2	6,11
011	3/4	9,08
013	1"	15,17
015	1 1/4	23,16
017	1 1/2	29,95
021	2"	46,67
023	2 1/2	89,09
025	3"	123,03
029	4"	191,76

Codigo:	MEDIDA	PRECIO (U\$/un)
279		
004	1/4	6,89
006	3/8	7,94
008	1/2	9,23
011	3/4	13,12
013	1"	18,84
015	1 1/4	31,05
017	1 1/2	36,65
021	2"	59,48
025	3"	152,26

LOS PRECIOS NO INCLUYEN IVA

MOLINA ARROTEA 1150 LOMAS DE ZAMORA (1832) BS. AS.

TEL: (+54 11) 4243 5823 / 4392 4278 / 4292 0965

E-MAIL : VENTAS@TUBULON.COM.AR

WEB: WWW.TUBULON.COM.AR

MATERIAL:	ACERO INOXIDABLE AISI 316 - A4
MEDIDAS:	ISO4144
TIPO DE	BSP - BSPT
TERMINACIO	PULIDO BRILLANTE
PRESION:	150Lbs
<b>DESCUENTO</b>	<b>BASE DE INOXIDABLE</b>



**ENTRERROSCA**

Codigo: 280	MEDIDA	PRECIO (U\$/un)
004	1/4	3,37
006	3/8	3,68
008	1/2	4,23
011	3/4	5,96
013	1"	7,89
015	1 1/4	13,39
017	1 1/2	14,76
021	2"	25,20
023	2 1/2	36,82
025	3"	51,67
029	4"	92,91



**CUPLA H-H**

Codigo: 290	MEDIDA	PRECIO (U\$/un)
004	1/4	2,55
006	3/8	2,92
008	1/2	4,07
011	3/4	5,28
013	1"	7,55
015	1 1/4	11,28
017	1 1/2	13,76
021	2"	18,98
023	2 1/2	28,41
025	3"	35,88
029	4"	60,28



**MEDIO NIPLE**

Codigo: 282	MEDIDA		PRECIO (U\$/un)
004	1/4	30	1,98
006	3/8	30	2,33
008	1/2	30	3,37
011	3/4	30	4,51
013	1"	50	6,33
015	1 1/4	50	9,37
017	1 1/2	50	11,08
021	2"	50	14,95
023	2 1/2	50	27,20
025	3"	50	41,08
029	4"	50	66,37



**NIPLE LARGO**

Codigo: 281	MEDIDA		PRECIO (U\$/un)
004	1/4	60	2,83
006	3/8	60	3,05
008	1/2	60	5,30
011	3/4	60	6,48
013	1"	100	9,33
015	1 1/4	100	14,52
017	1 1/2	100	17,84
021	2"	100	26,52
023	2 1/2	100	43,37
025	3"	100	65,05
029	4"	100	107,57



**ENTRONQUE MANGUERA**

Codigo: 284	MEDIDA	PRECIO (U\$/un)
004	1/4	3,96
006	3/8	5,07
008	1/2	6,37
011	3/4	9,80
013	1"	13,26
015	1 1/4	19,70
017	1 1/2	22,52
021	2"	37,80
023	2 1/2	57,60
025	3"	77,21

LOS PRECIOS NO INCLUYEN IVA



# TUBULON S.A.

MOLINA ARROTEA 1150 LOMAS DE ZAMORA (1832) BS. AS.

TEL: (+54 11) 4243 5823 / 4392 4278 / 4292 0965

E-MAIL : VENTAS@TUBULON.COM.AR

WEB: WWW.TUBULON.COM.AR

<b>MATERIAL:</b>	<b>ACERO INOXIDABLE AISI 316 - A4</b>
<b>MEDIDAS:</b>	<b>ISO4144</b>
<b>TIPO DE ROSCA:</b>	<b>BSP - BSPT</b>
<b>TERMINACION:</b>	<b>PULIDO BRILLANTE</b>
<b>PRESION:</b>	<b>150Lbs</b>
<b>DESCUENTOS:</b>	<b>BASE DE INOXIDABLE</b>



## PRECIO BUJE REDUCCION

<b>Codigo:</b> <b>285</b>	<b>MEDIDA</b>		<b>PRECIO</b> <b>(U\$/un)</b>
006	3/8	1/4	2,07
008	1/2	1/4	2,07
108	1/2	3/8	2,28
011	3/4	3/8	3,87
111	3/4	1/2	3,32
013	1"	1/2	6,69
113	1"	3/4	5,60
015	1 1/4	1"	8,71
017	1 1/2	3/4	14,14
117	1 1/2	1"	11,88
217	1 1/2	1 1/4	9,90
021	2"	1"	21,68
121	2"	1 1/2	19,80
023	2 1/2	2"	32,90
025	3"	2"	44,03
125	3"	2 1/2	46,76
029	4"	3"	81,45

## PRECIO NIPLE REDUCCION

<b>Codigo:</b> <b>283</b>	<b>MEDIDA</b>		<b>PRECIO</b> <b>(U\$/un)</b>
006	3/8	1/4	2,93
008	1/2	1/4	4,67
108	1/2	3/8	4,53
011	3/4	3/8	5,60
111	3/4	1/2	6,29
013	1"	1/2	9,00
113	1"	3/4	9,75
015	1 1/4	1"	12,67
017	1 1/2	3/4	15,72
117	1 1/2	1"	17,24
217	1 1/2	1 1/4	17,11
021	2"	1 1/2	28,19
023	2 1/2	2"	40,26
025	3"	2"	60,98
125	3"	2 1/2	60,98
029	4"	3"	104,43

LOS PRECIOS NO INCLUYEN IVA

MATERIAL:	ACERO INOXIDABLE AISI 316 - A4
MEDIDAS:	ISO4144
TIPO DE	BSP - BSPT
TERMINACION	PULIDO BRILLANTE
PRESION:	150Lbs
<b>DESCUENTOS</b>	<b>BASE DE INOXIDABLE</b>



## TAPON HEXAGONAL

Codigo:	MEDIDA	PRECIO (U\$S/un)
286		
004	1/4	1,47
006	3/8	1,81
008	1/2	2,17
011	3/4	3,25
013	1"	5,85
015	1 1/4	7,78
017	1 1/2	10,16
021	2"	17,22
023	2 1/2	33,19
025	3"	43,27



## TAPA HEXAGONAL

Codigo:	MEDIDA	PRECIO (U\$S/un)
287		
004	1/4	2,17
006	3/8	2,17
008	1/2	3,58
011	3/4	4,24
013	1"	6,87
015	1 1/4	10,95
017	1 1/2	13,15
021	2"	21,21
023	2 1/2	38,75
025	3"	53,74
029	4"	89,94



## TUERCA HEXAGONAL

Codigo:	MEDIDA	PRECIO (U\$S/un)
288		
004	1/4	0,98
006	3/8	1,19
008	1/2	1,41
011	3/4	1,73
013	1"	3,25
015	1 1/4	4,77
017	1 1/2	6,40
021	2"	10,84



## UNION 3 PZS H-H

Codigo:	MEDIDA	PRECIO (U\$S/un)
289		
004	1/4	10,99
006	3/8	13,07
008	1/2	14,93
011	3/4	18,36
013	1"	26,13
015	1 1/4	39,41
017	1 1/2	47,61
021	2"	67,62
023	2 1/2	110,07
025	3"	140,59

LOS PRECIOS NO INCLUYEN IVA

## ACOPLES RAPIDOS MACHO INOXIDABLE

MATERIAL:	ACERO INOXIDABLE AISI 316 - A4
TIPO DE	BSP-BSPT
TERMINACION	PULIDO BRILLANTE
PRESION:	150lbs
<b>DESCUENTOS</b>	<b>BASE DE INOXIDABLE</b>



(TNH)

### TIPO A - ADAPT HEMBRA

Codigo:	MEDIDA	PRECIO (U\$/un)
291		
008	1/2	7,00
011	3/4	9,80
013	1"	13,21
015	1 1/4	19,01
017	1 1/2	24,02
021	2"	30,52
023	2 1/2	53,94
025	3"	66,41
029	4"	96,77



(TNE)

### TIPO E - ADAPT RACORD

Codigo:	MEDIDA	PRECIO (U\$/un)
293		
008	1/2	6,44
011	3/4	9,57
013	1"	14,62
015	1 1/4	24,37
017	1 1/2	30,46
021	2"	39,16
023	2 1/2	59,18
025	3"	83,54
029	4"	135,76



(TNM)

### TIPO F - ADAPT MACHO

Codigo:	MEDIDA	PRECIO (U\$/un)
292		
008	1/2	7,14
011	3/4	11,05
013	1"	15,66
015	1 1/4	21,76
017	1 1/2	29,59
021	2"	36,99
023	2 1/2	53,95
025	3"	78,32
029	4"	123,57



(TTM)

### TIPO DP - ADAPT TAPON

Codigo:	MEDIDA	PRECIO (U\$/un)
298		
008	1/2	4,70
011	3/4	6,35
013	1"	9,57
015	1 1/4	15,58
017	1 1/2	19,41
021	2"	28,20
023	2 1/2	38,19
025	3"	54,83
029	4"	75,97

LOS PRECIOS NO INCLUYEN IVA

# ACOPLES RAPIDOS HEMBRA INOXIDABLE

<b>MATERIAL:</b>	ACERO INOXIDABLE AISI 316 - A4
<b>TIPO DE</b>	BSP-BSPT
<b>TERMINACION</b>	PULIDO BRILLANTE
<b>PRESION:</b>	150Lbs
<b>DESCUENTOS</b>	<b>BASE DE INOXIDABLE</b>



(TCM)

## TIPO B - CUERPO MACHO

<b>Codigo:</b> 294	<b>MEDIDA</b>	<b>PRECIO</b> (U\$/un)
008	1/2	17,40
011	3/4	16,45
013	1"	21,76
015	1 1/4	33,50
017	1 1/2	35,68
021	2"	45,34
023	2 1/2	65,09
025	3"	92,57
029	4"	134,10



(TCE)

## TIPO C - RACORD (OLIVA)

<b>Codigo:</b> 296	<b>MEDIDA</b>	<b>PRECIO</b> (U\$/un)
008	1/2	17,40
011	3/4	23,76
013	1"	24,37
015	1 1/4	36,55
017	1 1/2	39,16
021	2"	50,47
023	2 1/2	67,01
025	3"	96,78
029	4"	145,50



(TCH)

## TIPO D - CUERPO HEMBRA

<b>Codigo:</b> 295	<b>MEDIDA</b>	<b>PRECIO</b> (U\$/un)
008	1/2	14,97
011	3/4	15,66
013	1"	22,63
015	1 1/4	33,50
017	1 1/2	37,86
021	2"	46,99
023	2 1/2	66,70
025	3"	94,96
029	4"	113,04



(TTH)

## TIPO DC - CUERPO TAPA

<b>Codigo:</b> 297	<b>MEDIDA</b>	<b>PRECIO</b> (U\$/un)
008	1/2	14,62
011	3/4	15,66
013	1"	21,76
015	1 1/4	31,15
017	1 1/2	31,59
021	2"	40,55
023	2 1/2	54,56
025	3"	77,34
029	4"	92,25

LOS PRECIOS NO INCLUYEN IVA